



Figure 1 – Assembled K44

Introduction

This document will describe how to assemble and test a K44 Kit. The assembly requires reasonably good soldering skill. Before you start working, gather the following items:

A low wattage (40W) soldering iron with fine tip, preferably temperature controlled.

Good grade of Rosin core solder, Please do not use ACID CORE Solder !!

A pair of wire cutters, small pliers, and assorted screwdrivers.

A Volt Ohmmeter or DVM is recommended.

A magnifying glass is certainly helpful.

Power supply providing a voltage between 8 to 11 VDC (9VDC is optimum) at about 150 ma.

An audio signal generator is optional; the kit can be tested without one.

It is very important to take your time and carefully follow the instructions and assembly photos. We also have several K44 assembly videos on our website that can be very helpful.

The instructions will take you through a step by step assembly process. The PC board is 100% tested before shipping so you should have little if any problems. Please don't assemble the kit in a manner other than as described, the order of the steps is very important from a mechanical perspective and if you don't follow them you can end up with a kit that can't be completed.

These instructions assume you have electronic kit building experience and can identify different types of electronic components. Photos are provided which will greatly aid in assembling the kit correctly. The biggest enemy of kit success is poor soldering, so please take care with each solder joint, and use just enough heat and solder to get a good connection. A good solder joint should be both shiny and smooth. See the appendices A, B, and C at the end of this document for additional kit building advice.

Bill of Materials

The bill of materials is listed below. The first step is to inventory and identify all parts ahead of time. This will allow the assembly to proceed smoothly. The parts are packed in separate compartments. We try to do a good job putting the kits together but sometimes we make mistakes, let us know if you are missing any parts. We keep track of our errors. If you lose or damage a component, or solder it in the wrong location, let us know.

Reference	Qty	Part Description	Other Info	Check Off
BD1	1	K44 Rev E PC Board	SMT parts attached and pre-tested	_____
U3	1	CY8C27143 PSoC	8 pin DIP IC	_____
U5	1	PIC16F1825 Keyer PIC	14 pin DIP IC marked w/dot	_____
U7	1	PIC16F1825 Console PIC	14 pin DIP IC	_____
D2,D3,D4,D5	4	CWR Tuning LEDs	Right Angle Green	_____
D6	1	CWR Tuning LED	Right Angle Red	_____
DP1	1	Sunlike SD1602H	LCD Display Module	_____
SP1	1	Mini Speaker	Cylindrical w/2 leads	_____
J1,J2,J3	3	Stereo Phone Jack	1/8 Inch Jack, PC mount	_____
J4	1	Keyboard Connector	PS2 6 Pin DIN	_____
J5	1	Power Connector	2.1 mm female receptacle	_____
ENC1	1	Rotary Encoder	Panel Mount	_____
ENC-BKO	1	K44 Encoder I/F Board		_____
MISC	1	Rotary Encoder Hex Nut	(this may be on encoder shaft)	_____
MISC	1	Rotary Encoder Flat Washer	(this may be on encoder shaft)	_____
MISC	1	K44 Enclosure		_____
MISC	1	Control Knob	Plastic 1/4" shaft	_____
MISC	4	Rubber Feet	Press in	_____
MISC	1	16 pin Header	Right Angle for LCD mounting	_____
MISC	2	4-40 Hex Nuts	Used during LCD assembly	_____
MISC	4	4-40 1/4" Screws, Black	(for enclosure lid	_____
MISC	4	4-40 1/4" Screws	For PCB mounting	_____
MISC	2	14 pin DIP socket	Used for U5 and U7	_____
MISC	1	8 pin DIP socket	Used for U3	_____
MISC	1	10" length insulated wire	Used to attach encoder to PC board	_____
MISC	1	DC Power Supply	Wall mount (USA and Canada kits only)	_____
MISC	1	Power supply connector	2.1mm plug (Outside USA and Canada)	_____

Step By Step Assembly Instructions

- 1) After inventory, carefully inspect the PCB for defects or damage. As previously mentioned, The K44 PCB is pre-assembled with all surface mount parts attached and it is fully tested before shipment. It's very unlikely you will find any problems, but it's easier to find one now before we solder anything to the board.

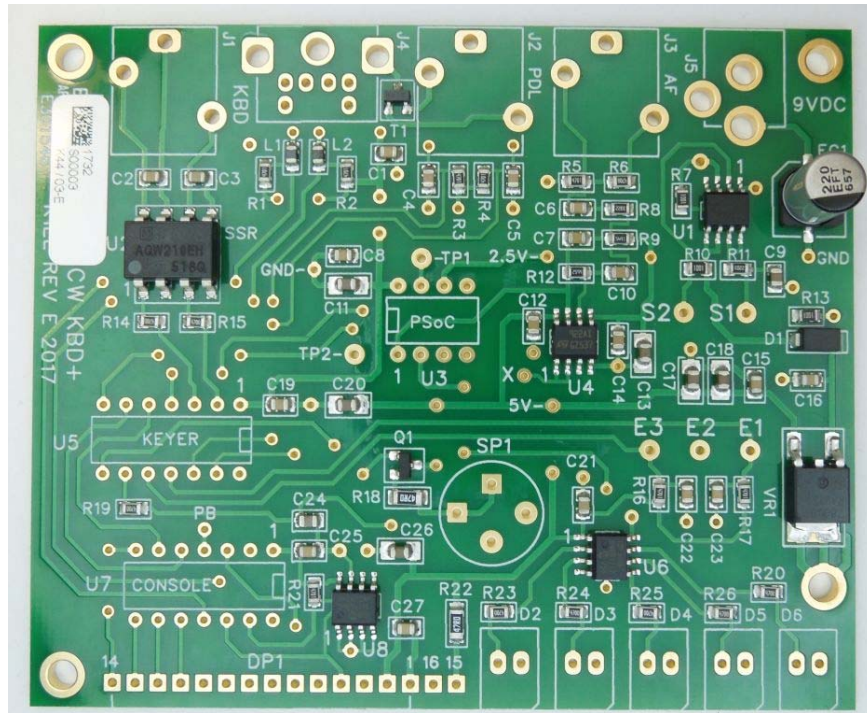

Figure 2 - Board as shipped from K1EL Systems

- 2) To start, install the 8 pin DIP IC Sockets at locations U3. Be sure to align the notch in the socket with the silkscreen as indicated by the red arrows in the picture below. Do Not Install U5 or U7 sockets yet.



Figure 3 – U3 Socket installed, red arrow indicates socket notch location

- 3) Install three 1/8" Stereo Phone Jacks J1, J2 and J3 as shown. Make sure these sit flush to the back of the PC board and within the silkscreen outlines.

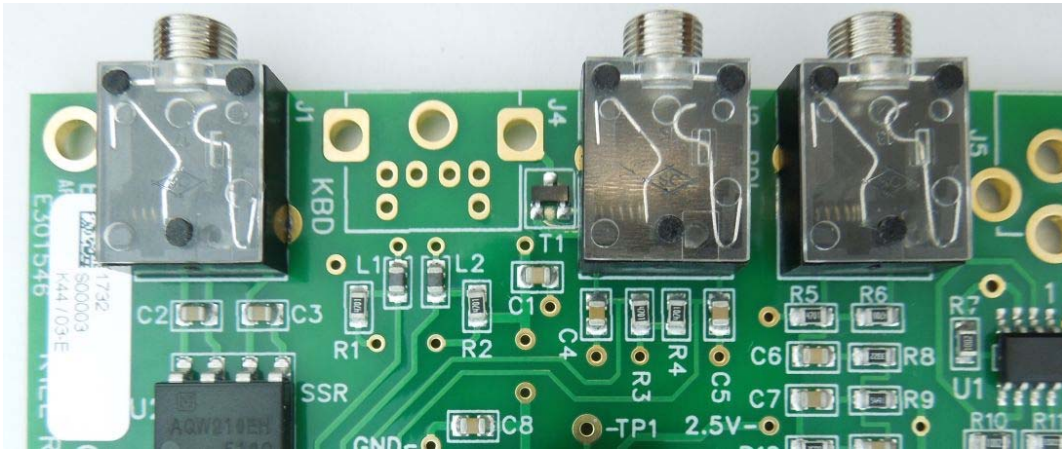

Figure 4 - Three Phone connectors installed

- 4) Install the 6 pin DIN Keyboard connector J4 and the 2.1 mm DC power jack J5.

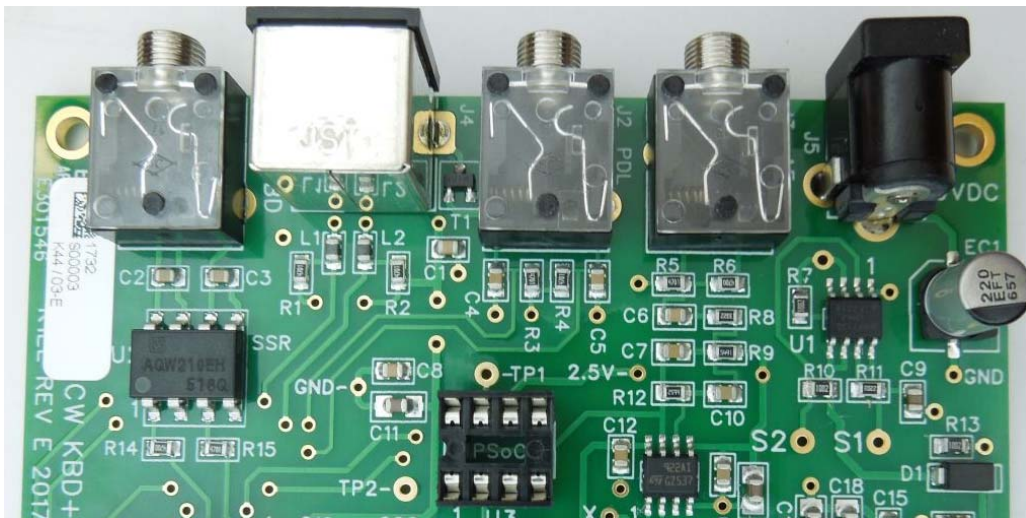

Figure 5 - DIN connector and power connector in place.

- 5) Install five GREEN LEDs D2-D5 and one RED LED D6. Solder and trim component leads.

We want to install the LEDs so that they are all even with the front edge of the board and there is equal space between them. The best thing to do is start in the middle and work your way right and left. Put in D4 first, tack solder one lead and tweak the placement to get the front edge aligned right. Then install D3 the same way and space it so that D3 and D4 are parallel to each other. Go back and forth D3, D4, D5, D2, D6 with D6 being the RED LED. It should look at least as good as the picture below when you are done. Please spend extra time with this because you will see the bodies of the LEDs through the front panel and the better they look, the better the whole assembly will look. Please note that some kits will include a red LED that is in a slightly shorter package, as shown in the picture below. You may have to bend the leads forward to get the tip of the LED to align with the green LEDs, note that the package of the LED will set back in this case. When all LEDs are installed, finish soldering and trim leads.



Figure 7 - LEDs installed, note RED LED is on the right side !

- 6) LCD display Installation

This can be the most challenging step in the K44 assembly. Read through the entire procedure so that you understand how it is done. If you make a mistake here, it will be very difficult to fix it so go slowly and follow each step closely.

NOTE: the LCD module uses a delicate film ribbon interconnect which can be easily torn or damaged by soldering iron. When picking the display up try to hold it by the sides avoiding contact with the ribbon.

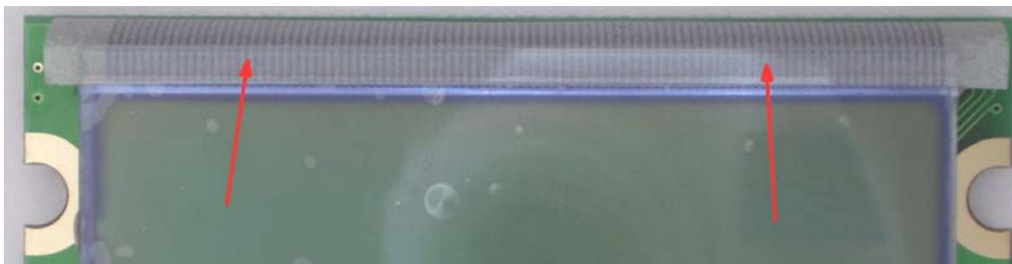

Figure 7 – Caution, do not damage ribbon film interconnect

Begin by installing four rubber feet into the bottom of the enclosure base and set it aside.

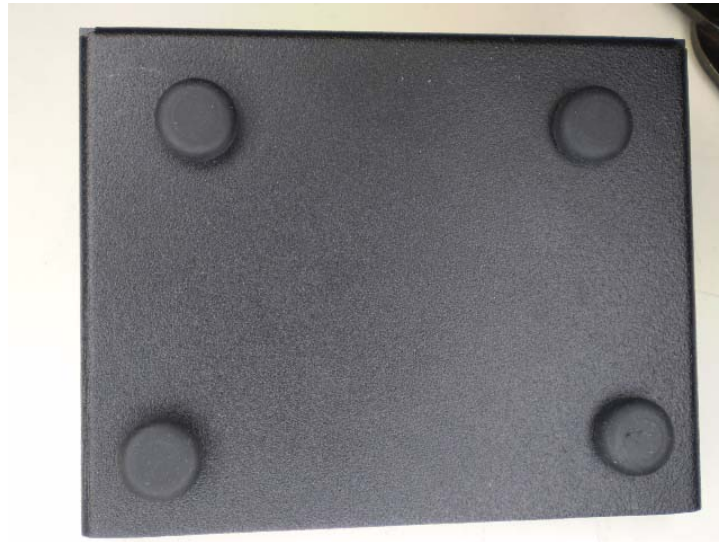

Figure 8 - Rubber feet in place on bottom half of enclosure

Insert the 16 pin header into the LCD module as shown in figure 9. The plastic bracket on the display module may make this a bit difficult. If you start with the header at an angle it will help. Once in place, make sure the header is fully seated but **do not solder this yet !**

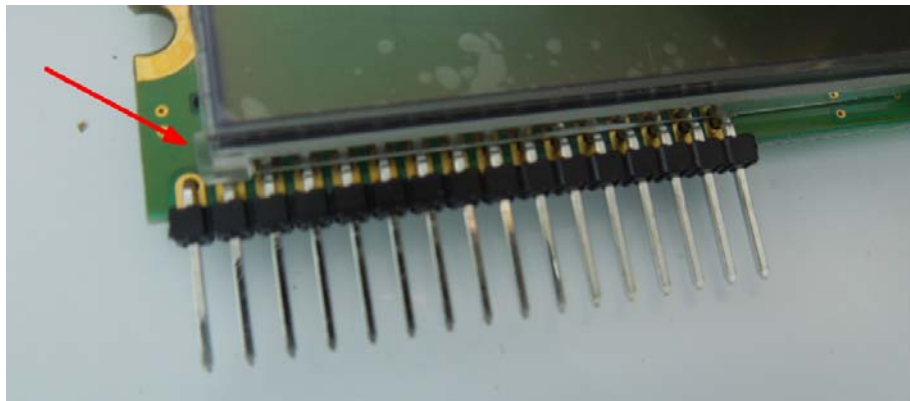

Figure 9 – Insert header into display module

Now fit the LCD/Header sub-assembly into the K44 PC board as shown in figure 10.

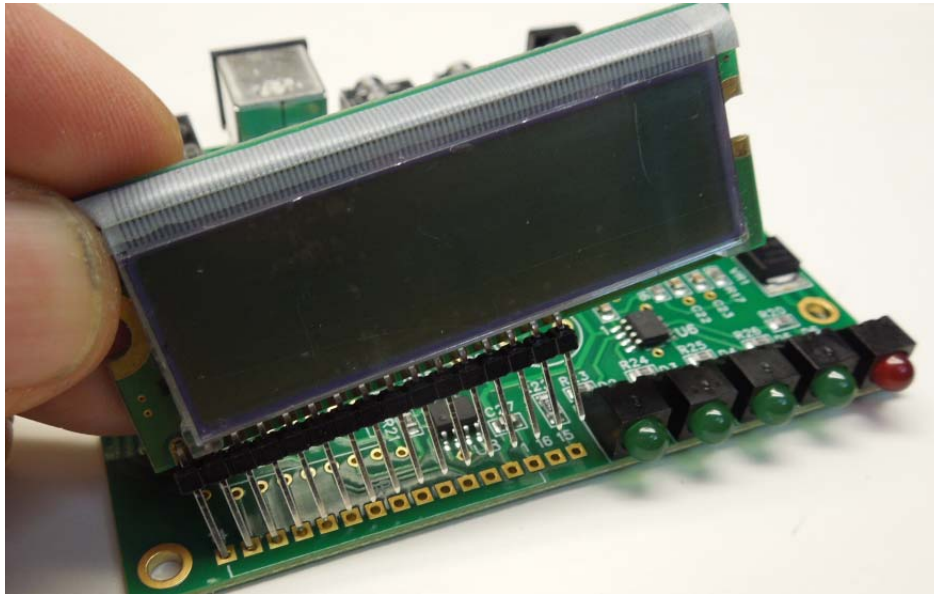

Figure 10 – Insert subassembly into K44 PC board

Now slide this loose sub-assembly in place into the enclosure base. Carefully fit the display notches over the threaded studs on the front panel. Note that the header should naturally seat into both the LCD module and K44 board, if you find yourself forcing anything you probably have something misaligned.

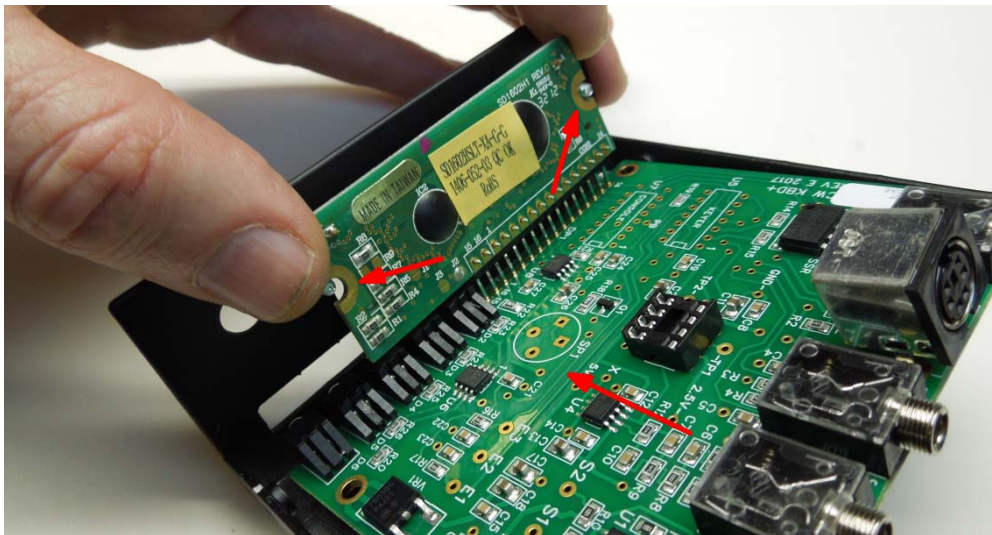

Figure 11 – Slide subassembly into K44 enclosure base on threaded studs



Figure 12 – Subassembly in place on K44 enclosure base

Attach the K44 PC board to the base with two 4-40 screws. Fix the LCD display to the front bezel with two 4-40 nuts. Only use enough force to hold the display in place so it is nearly flat against the front panel and centered in the enclosure display window.

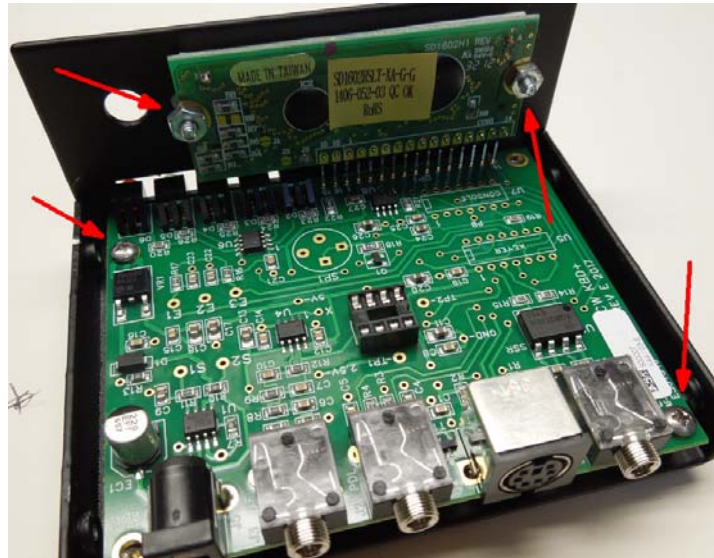

Figure 13 – Add 4-40 nuts and screws to hold subassembly in place

Double and triple check the alignment and make sure the header is fully seated into the LCD display module. Loosen the display nuts if necessary to get a good centered display alignment then re-tighten

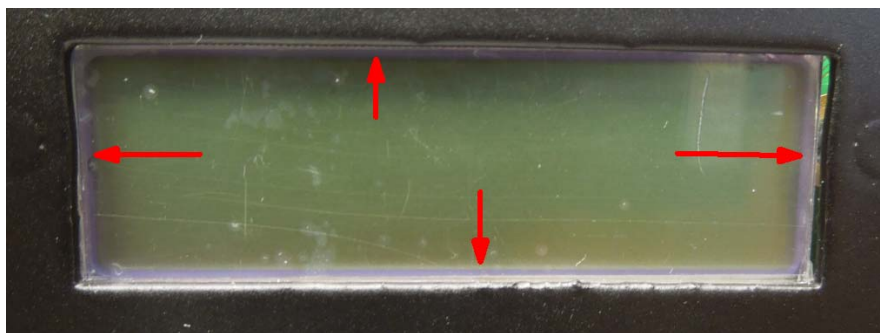

Figure 14 – Center the display window in the enclosure opening

Before soldering, you may have to very gently pull the header back into the LCD module with a thin long nose pliers. We want all of the header pins to stick out roughly the same on each end.



Figure 15 – Gently adjust header for equal pin alignment

Now carefully solder the two end pins on the LCD module and then two end pins of the header to the K44 board. It's easier to get at pin 16 on the K44 board since it is further away from D2's LED housing.



Figure 16 – Solder four places to fix display alignment

Remove the 4-40 nuts and 4-40 screws and extract the assembly from the enclosure base. Now solder the unsoldered pins on both sides of the header. Be sure to NOT start with the end pins you just soldered since that will spoil the alignment you just carefully set.



Figure 17a – Solder remaining connections on display

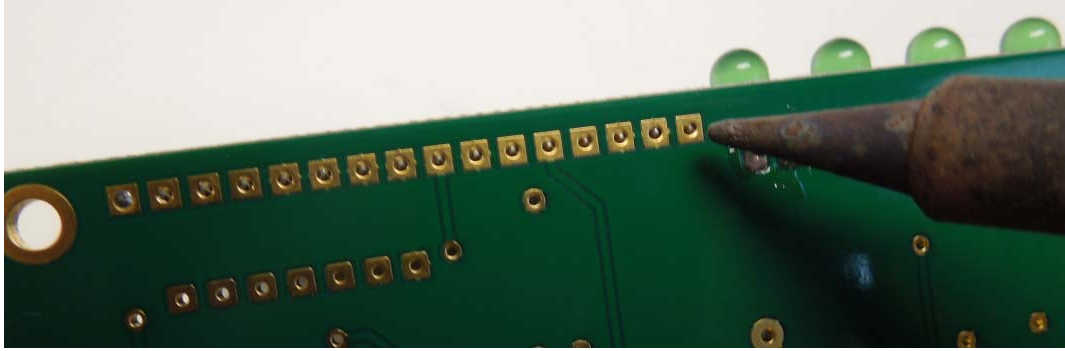

Figure 17b – Solder remaining connections on K44 board

Display assembly is now complete !

- 7) Install and solder two 14 pin DIP sockets at locations U5 and U7. Align the socket notches with the silkscreen as indicated by the red arrows in Figure 18.
- 8) Install the mini speaker SP1. There are four holes in the speaker footprint, choose the pair that fit the speaker that came with your kit. The polarity marker position should match the picture below. Leave the protective film cover in place until PCB assembly is complete.

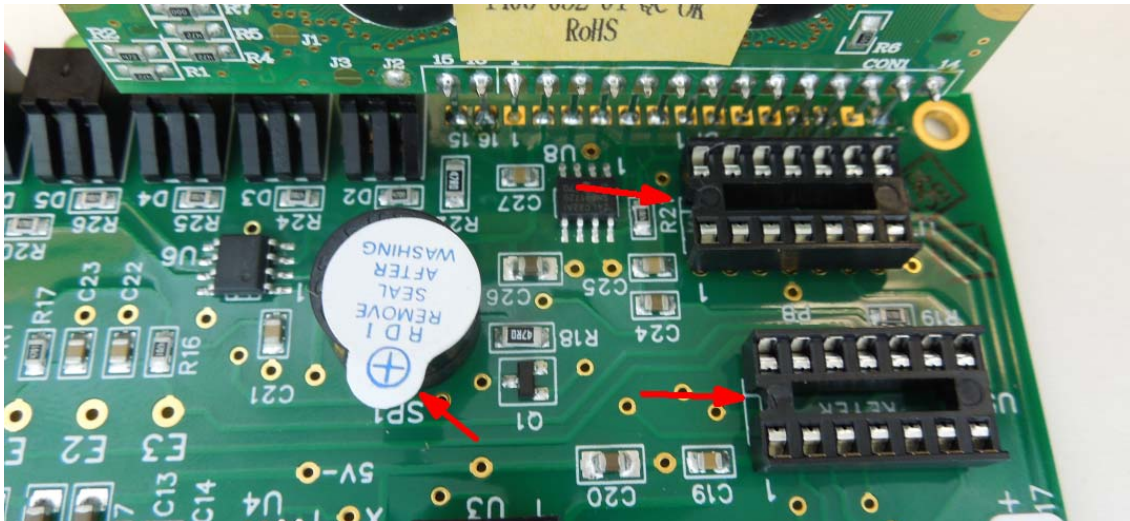

Figure 18 – U5 and U7 Sockets and Mini-speaker installed

- 9) Next install the 8 pin PSoC microprocessor at U3. Install the 14 pin PIC16F1825 with colored dot at U5. Install 14 pin PIC 16F1825 with (no dot) at U7. Be sure to match the IC notch with the socket notch for correct polarity. Remove the protective film from the mini-speaker.

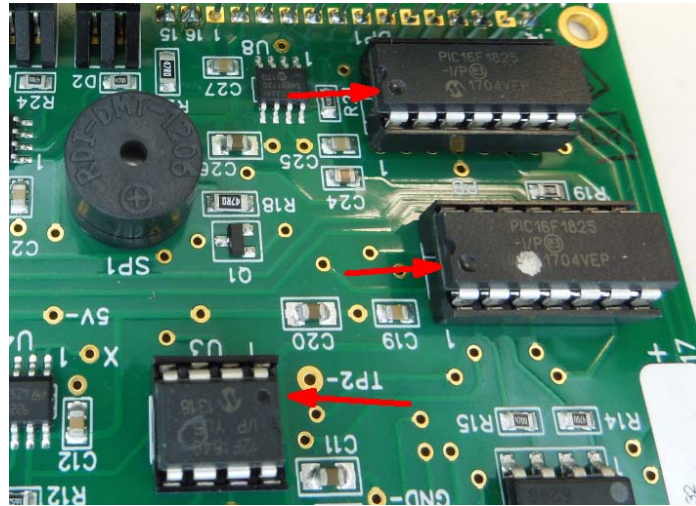

Figure 19 – Three Integrated Circuits (ICs) installed

- 10) Now it's time to work with the rotary encoder. Locate the rotary encoder and encoder PCB seen below. Make sure the threaded encoder shaft fits into its mounting hole on the enclosure front panel. You may need to remove some paint on the inside of the hole to get a good fit. After attaching wires to the encoder board the encoder will be attached on the correct side of the encoder board as indicated.

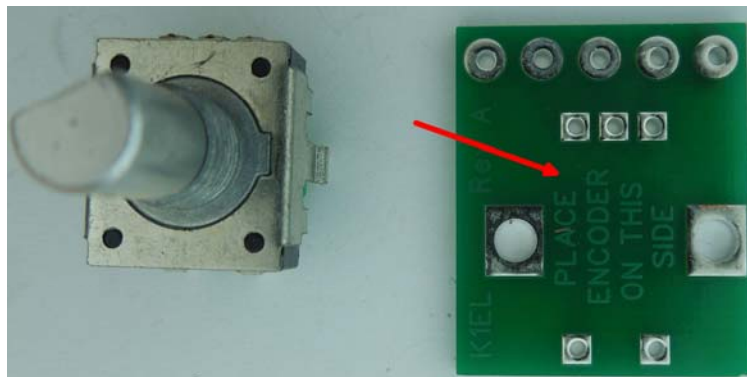

Figure 20 - Encoder and encoder PCB

Prepare five wires, two are 2.5 inches long and three are 1.5 inches long. Strip and tin both ends. Solder wires to PCB as shown in the picture. This step is much easier if you use a board vice or clamp to hold the encoder board steady while you solder wires to it.

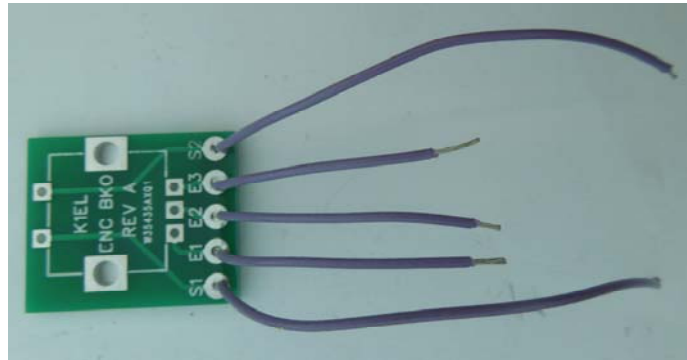

Figure 21 - Wires attached to encoder board

Mount the encoder on the proper side of the PCB per text on PCB. It's not necessary to completely fill the bracket mounting holes with solder.



Figure 22 - Encoder on encoder PCB

Solder the 5 wires from the encoder PCB to the K44 PCB as shown, matching E1 to E1, E2 to E3, etc. It's much easier if you solder in the E3, E2, and E1 wires first.

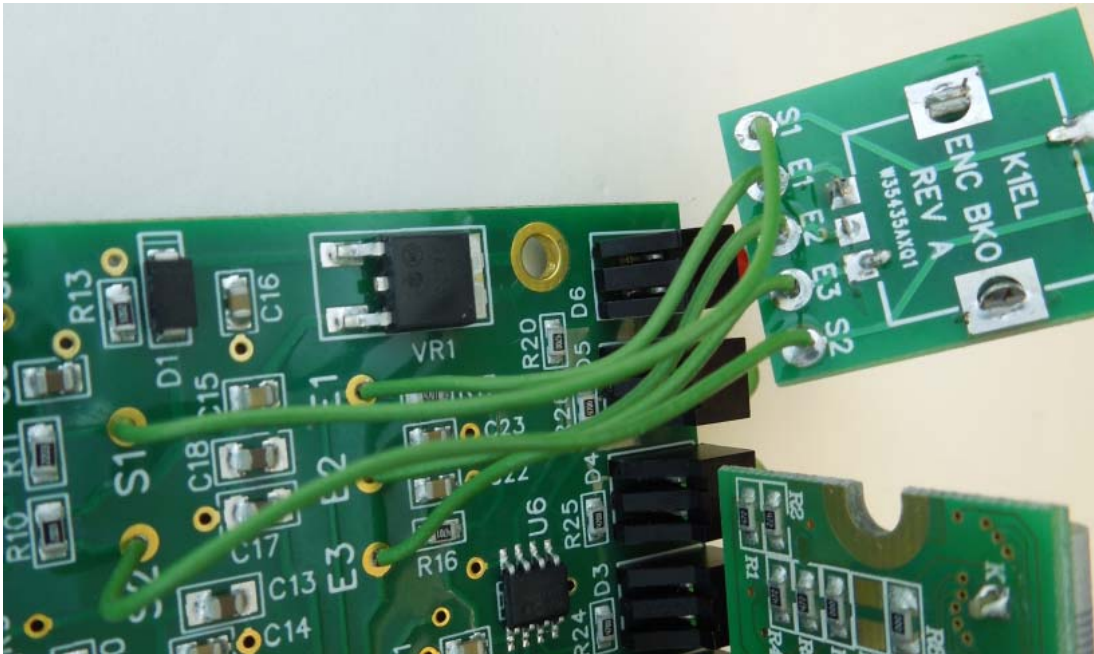

Figure 22 - Encoder PCB attached to main K44 PCB

- 11) Peel off the thin protective film from the front of the LCD display.



Figure 23 - Don't forget this step or the display will look foggy !

- 12) Re-install the PC board assembly into the chassis by carefully folding the board back in place first on to the threaded studs then on to base mounting studs. Install and tighten the four silver 4-40 board mounting screws. Please do not reinstall the two display hold down nuts. The soldered header is mechanically strong and is all that is needed to support the display. More often than not, builders will over tighten the nuts and damage the LCD display or under tighten them so they work their way loose and fall on the board causing a damaging short circuit. **Bottom line, do not attach the display holding nuts !!**



Figure 24 – Rear view with encoder and display in place

- 13) The encoder is mounted with one hex nut and one flat washer. The washer and nut both go on the front of the unit. Reference the picture above to see how this is done. Be careful when tightening the nut, it's easy to slip and scratch the front panel. Now attach the rotary encoder knob using a small screwdriver.

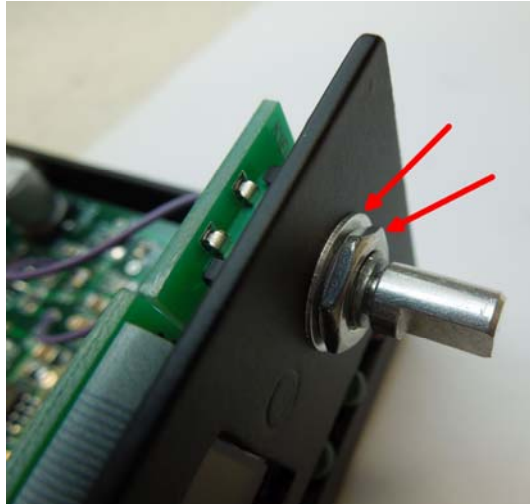

Figure 24 – Placement of encoder flat washer and hex nut

- 17) To install the top cover, angle it so the rear connectors just start to go into the place. Then fold the cover down to meet the front panel and push it forward so the three 1/8 inch connectors poke out the back evenly. Install the four black 4-40 screws to hold the cover in place.

K44 Test Procedure

- 1) First thing to do is attach the K44 to power. US kits ship with a power supply, so plug that in. If you don't have a power supply, the K44 accepts a 2.1 mm power connector with center pin positive. The voltage should be in the range of 6 to 11 VDC at 150 mA. Turn K44 power on by pressing the encoder knob and the LEDs will run a self test pattern. D1->D2->D3->D4->D5 then in reverse. This is followed by two alternating LED patterns. All LEDs will turn off after the test is complete.
- 2) During the LED test, the LCD backlight will turn on followed by a start up message. This message will display the PIC and PSoC versions along with other status as indicated in the figure below. If the display contrast is not satisfactory, we will show how to adjust it in step address that in step 8. After the LED test completes, the K44 will send an 'R' in sidetone, and the start up display will automatically clear.

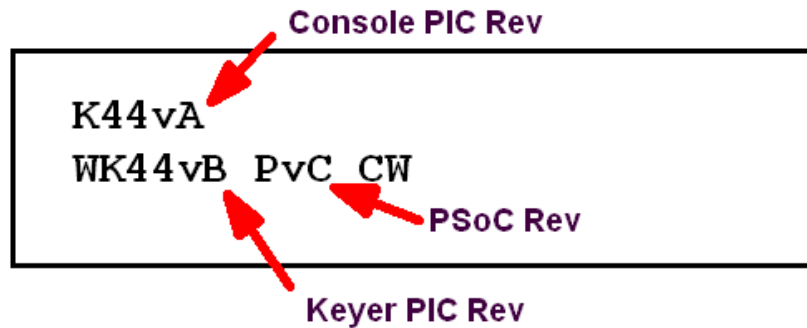

Figure 25 – Start Up Display

- 3) Console PIC Test: Turn K44 power off by pressing the encoder knob. Now attach a PS/2 keyboard and turn the power back on. We need to load a default keyboard table before we proceed. Simply press the Scroll Lock key and you will see FCR? displayed. Respond by hitting Scroll Lock again and the K44 will restart, load a keyboard table, and display QWERT. Now when you type on the keyboard you will hear CW sent in sidetone and also see letters displayed on the LCD display. If you want to change the keyboard mapping press CTL-ALT-INS and you can toggle between QWERT and AZERT layouts. Now that we have a keyboard attached we can adjust the display contrast. Press ALT-LEFT and ALT-RIGHT to change contrast.
- 4) Keyer PIC Test: Plug your keyer paddle into J3, it's assumed that your paddle set cable has an 1/8" stereo plug with left paddle connected to the tip. When you press the paddles you should hear dits when the left paddle is pressed, dahs when the right paddle is pressed, and alternating dits/dahs when both are pressed.
- 5) Keying Output Test: Make up a keying cable that has an 1/8" stereo connector on one end (K44) and an appropriate key connector on the other side that will plug into your transceiver keying input. This is usually a 1/4" phone plug. Before plugging into your radio, it's a good idea to verify keyer output. By measure the resistance across the tip and sleeve of the key connector. When you key either by paddler or keyboard, you will see the resistance change in sync. If you measure between ring and tip, you will see the PTT resistance go low as long as keying is active. Meter lead polarity doesn't matter since the output emulates a relay contact.



Figure 26 – Key Output Connector

- 6) PSoC IC Test: During power up two LED test patterns are displayed, the second one showing two alternating LED patterns (two and three LEDs) test the path between the PSoC and the LED controller. TO test the PIC to PSoC path enter ALT-F2 and the default CWR speed will be displayed.

- 7) Rotary Encoder Test: Simply turn the encoder and you should see the current WPM value updated on the upper left side of the LCD display. The WPM value will increase when you turn clockwise and decrease when you turn counter-clockwise. The WPM readout will disappear a few seconds after you stop turning the encoder.
- 8) The CWR tone filters are verified at the factory before shipping, there is no need to spend time verifying this particular function. However, if you have an audio frequency generator you can run a quick test. First of all, power up the K44 and hit ALT and F1 keys together, you should see **CWR On** displayed.

Now in order to feed audio into the K44 you will need to make up an audio cable. This will consist of an 1/8" mono or stereo plug on one end and bare leads on the other. Audio will be applied between the tip and sleeve of the connector. On your signal generator, select a frequency range that will cover a sub range close to 500Hz through 1000Hz. Set the output lever to minimum and connect the K44 audio cable leads to the signal generator output. Now plug the other end of the cable into the K44. Set the frequency to 725 Hz and slowly increase the signal level until you see the LEDs start to light. Stop when you see the rightmost red LED turn on. Now adjust the frequency back and forth around 725 Hz and you should see a definite peak close to 725Hz. It may not be exact due to signal generator calibration or allowable error in the K44. As long as it's close and there is a definite peak we are done.

- 9) Using a receiver as an audio source brings several issues. If you simply plug into a receiver's external speaker output you will not be able to hear anything because you are replacing the speaker output with the K44 which only consumes audio and does not have its own internal speaker. The ideal place to take receiver audio from an audio line out connector. Every radio is different, some put this on a connector labeled RTTY, Packet, Data, or if you are really lucky, and RCA jack marked Line Out. Odds are the line out connection is on a DIN connector which might be labeled AUX, AUX1, or AUX2. I know it can be confusing but well worth pursuing. The beauty of using Line Out is that it is a fixed level not influenced by the AF gain control.

If you want to skip line out, you can do a quick connection by using an external speaker connection and connecting that to an external speaker. Then tap K44 audio across the speaker. Observe the fact the one side of the speaker will be connected to ground so make sure that side goes to the K44 ground side.

- 10) Now is the time to give the K44 a good workout, go through the K44 User Guide and try out some of the commands and message features. It will take some time to get through everything. If you have not done it, take some time to make up any interconnecting cables you may need, the following diagram shows the connector layout on the K44 rear panel. As previously mentioned, a power supply is included with US kits so that part is easy. Note that stereo plugs are shown in the drawing below. A stereo plug is only required if you want to use PTT or two keying ports on the KeyOut jack.

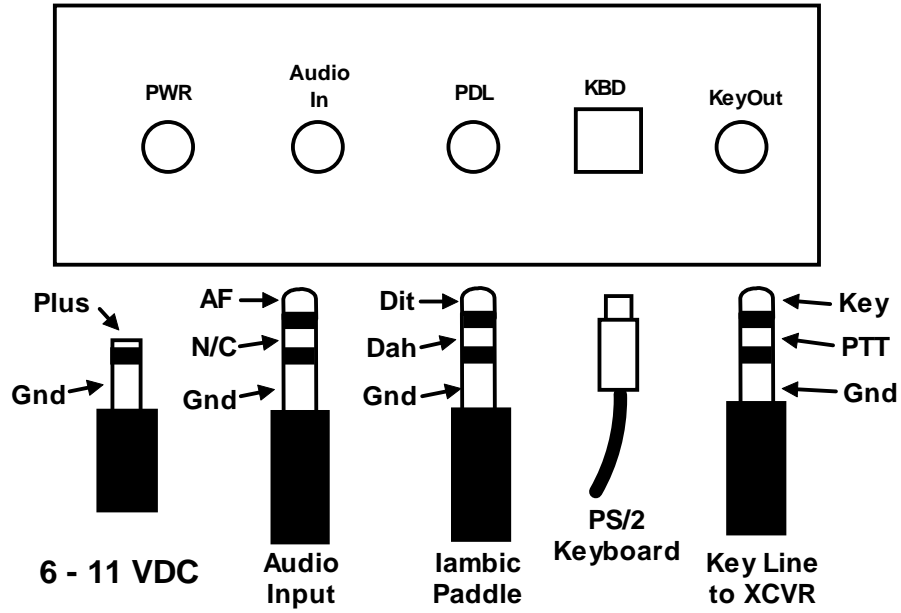

Figure 27 – K44 Back Panel Connections

Appendix A - Kit Construction Hints

1. Find a good workspace.

It is essential that you have a good place to work on your kit,

You will need room to spread out your parts and have access to tools. Good lighting and ventilation is essential. A magnifying glass or hood is highly recommended.

2. Have the proper tools.

At a bare minimum you will need:

Small side cutters, flush cutters are a plus.

Small needle nosed pliers

Small flat blade & Philips head screw drivers

A good quality, 40-60Watt, temperature controlled Soldering Iron. The price has come down on these; you can buy a Weller WLC100 40W adjustable soldering station for \$40 on Amazon.

3. Read the Instructions First.

Read through the assembly instructions completely and have everything on hand before you start. Carefully inventory the kit parts, make sure you have everything.

4. Follow the assembly instructions in order.

Although not always obvious, the order in which parts are installed is important and should be followed. Sometimes individual sections are completed and tested in order or there may be mechanical clearance considerations.

5. Keep your Workplace Clean and Orderly.

Nothing spoils a kit building experience more than lost parts. Second to that are stray bits of dirt and metal that get on a printed circuit board assembly. Our PC boards are nicely plating and accept solder easily. There is no need to use solder flux or to clean the board with steel wool before starting.

6. Take your time.

There is no need to rush, enjoy the process and the difference will show in the end result. Moving too quickly or working when you are tired often leads to big mistakes which could be difficult if not impossible to fix.

Appendix B - Note About Safety

Burns to your skin can be very painful and can lead to serious injury.

Burns to your eyes can be catastrophic.

Toxic fumes can cause serious harm.

Flying objects such as wire ends etc. can cause painful and serious injuries.

When building your kit please remember that Soldering Irons and Solder are used at High Temperatures!

Soldering Irons can remain hot for many minutes after being turned off. Never touch the tip to see if it is hot. Place the tip on a wet pad to test for temperature.

Wear safety glasses to protect your eyes from flying objects.

Appendix C - Soldering Basics

1. Insert component leads into PCB holes and bend them back slightly to hold the part in place. You can either trim the lead now or wait till after the joint is soldered. I usually install several parts at one time and then solder and trim multiple leads in groups.
2. Place a hot and clean iron tip against both the lead and pad as in Fig. C1.

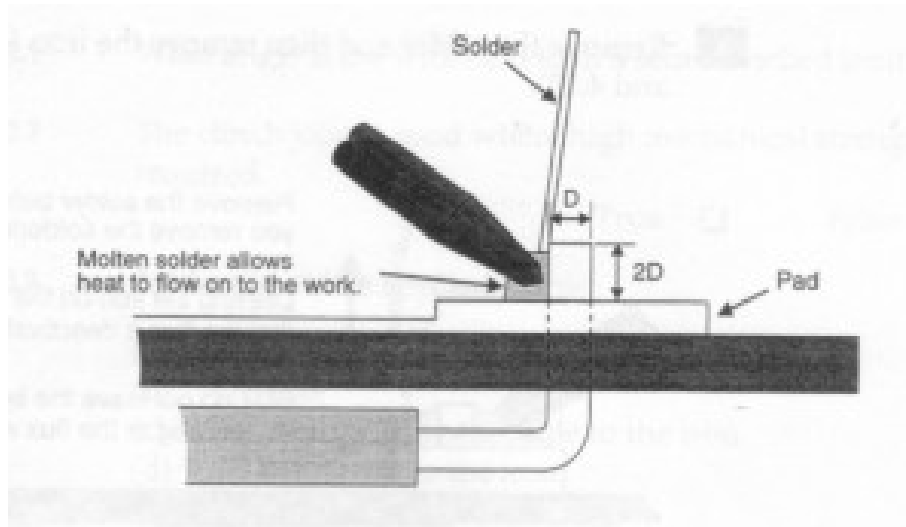

Figure C1 - Form a heat bridge

3. Create a heat bridge between the lead, the PCB pad and the iron by placing a small amount of solder on the tip.
4. Apply solder around the outside edge of the pad as in Fig. C2. If the pad and lead are at the correct temperature, the solder will flow around the connection.

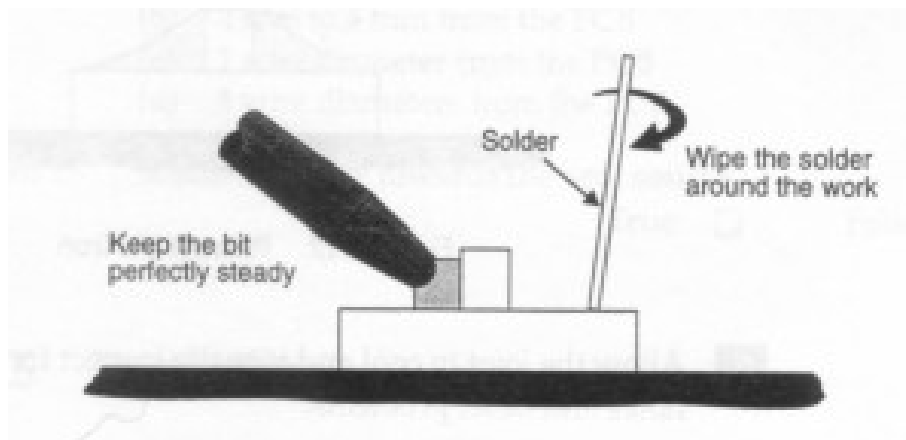

Figure C2 - Spread solder around the work

5. Remove the solder and then remove the iron:

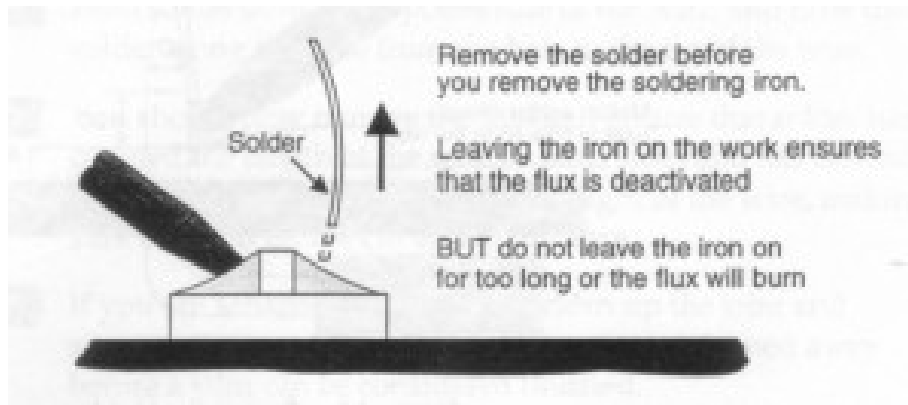

Fig C3 - Remove the solder

6. Allow the joint to cool and visually inspect for defects or other problems. You should have a solder joint with a bright shiny finish and a profile like that shown in Fig. C4.

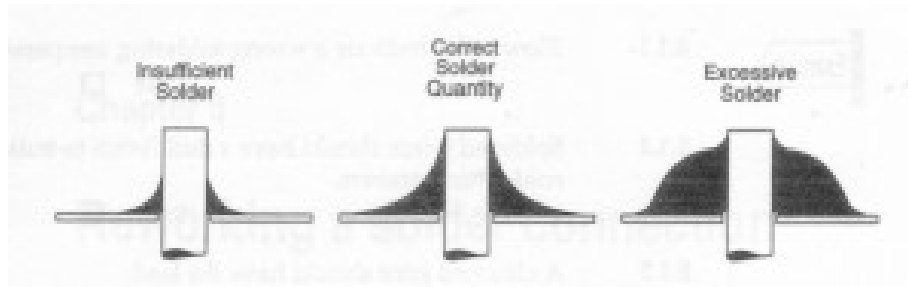

Figure C4 - Solder quantity comparison