

# OpenQRP Transceiver Assembly Guide – Rev 0.8

## June 17, 2013 - K1EL

### Introduction

There are two additional documents you need to download, the Schematics and the Parts List. Both of these can be found on [www.openqrp.org](http://www.openqrp.org) in the column on the right.

I have divided the build into small sections which match the way the parts are kitted in the plastic bags. The parts list identifies parts for each section by board reference designators, description, and board grid location. The board grid is presented on the last page of the parts list. Note that in some cases the parts of a section are not always grouped together in one area.

As the build progresses, checkout procedures to verify operation are provided.

### Ground Rules

Here's a list of tools and equipment you will need:

- 1) A good soldering iron, pencil type, temperature controlled is a plus.
- 2) Wire cutters to trim leads, small pliers, screw drivers, xacto knife, and wire strippers.
- 3) Small plastic screwdriver/alignment tool to adjust IF cans.
- 4) 12-15 volt DC power supply
- 5) Multimeter, digital is a plus, to measure DC voltage, resistance, current
- 6) Oscilloscope or RF probe.
- 7) Impedance, or LC-meter is not required but is certainly helpful  
<http://www.aade.com/lcmeter.htm>  
<http://sites.google.com/site/vk3bhr/>
- 8) General coverage receiver, helpful for checking VFO
- 9) Small speaker or headphones mono or stereo with 1/8 inch phone plug
- 10) Set of CW paddles (with 1/8" stereo connector)
- 11) BNC interconnect for antenna connection
- 12) Low power wattmeter for peaking TX stages.

A frequency counter is not required as one is built into the transceiver.

At the time of this writing, the current firmware release is revision E. This provides a very reasonable set of features. If you are interested in customizing the operation of the radio, the Arduino sketch and associated libraries are available for free. You will first need to install the Arduino IDE which can be downloaded from [www.arduino.cc](http://www.arduino.cc). This will allow you to make changes to the sketch and compile a new version. To upload the sketch to the radio you will need an ISP programmer. Make sure you find one that is compatible with the Arduino development IDE. The best choice is [USBtiny](http://USBtiny) which is sold by Adafruit [www.adafruit.com](http://www.adafruit.com) and is very reasonably priced.

## Sections 1-5 - Power Supply

There are several power supply sections, each one is described below. They are all derived from the main 12 volt supply.

### Section 1 – AGND (Analog Ground)

This is simply a resistor divider made up of two 10K resistors and filter caps. It divides the 6v supply in half to get 3.0V. We will test this later after installing the 6V supply.

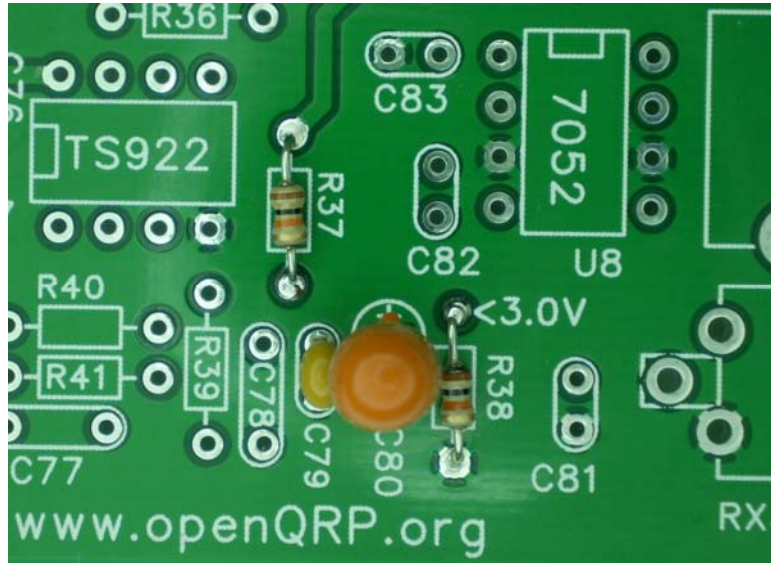

### Section 2 – 12V Power Input

Install J3 so that it sits flush on the board and is aligned with the silkscreen.



Note that the S7 pads (next to J3) are provided to allow a power switch to be added easily. This assembly guide assumes that S7 is jumpered and that a switch, if desired, will be added later.

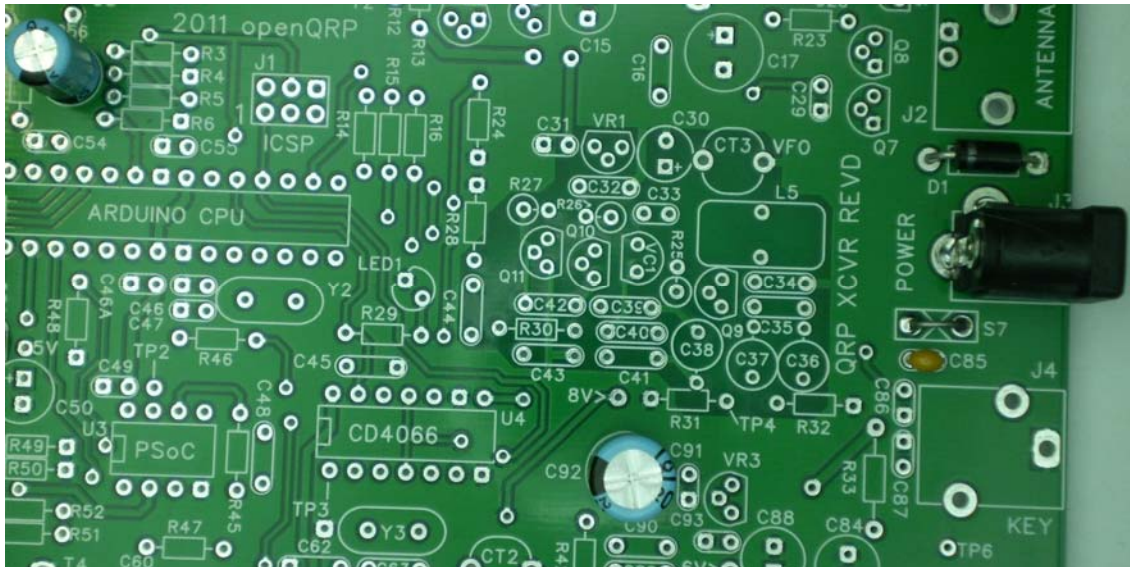

A preassembled 12V power cord is included in the kit; this will save you the trouble of making one. Observe polarity, the wire with the white stripe goes to +12V. I connect the cable to the power supply first and then check the connector end with a voltmeter. The center pin must be positive in reference to the barrel of the connector. Once you are sure it's correct, plug it into the OQ board. For a quick verification, you should see +12V between the S7 jumper and ground (anode side of D1). Remove power and add the next three sections then test each section to make sure you have the correct voltage. There are test points on the board for each voltage.

### Section 3 – Digital 5 Volts

Install the LM7805 regulator VR2 (TO220 package), orient it so that the heat sink tab aligns with the silkscreen. A filter cap is also installed. The 5V test point is next to C50:

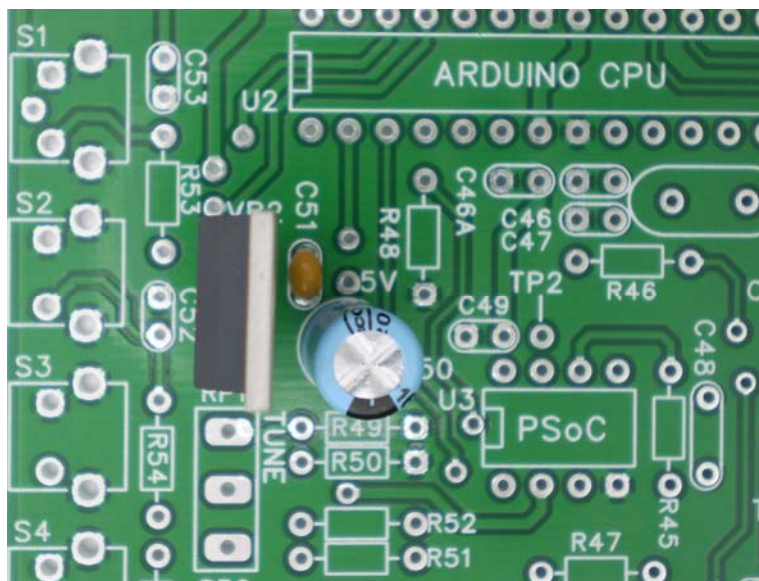



## Section 6 - Arduino CPU

There are a large number of components in this section. It's easier if the caps and resistors are installed first. The 28 pin socket for the CPU is made up of two 14 pin sockets. When installing the 16.384 MHz crystal, make sure that its base does not rest on the PC board. To prevent this, I cut a thin strip of cardboard; insert it between the crystal and PC board as shown below. Solder the leads, and then remove the cardboard strip.

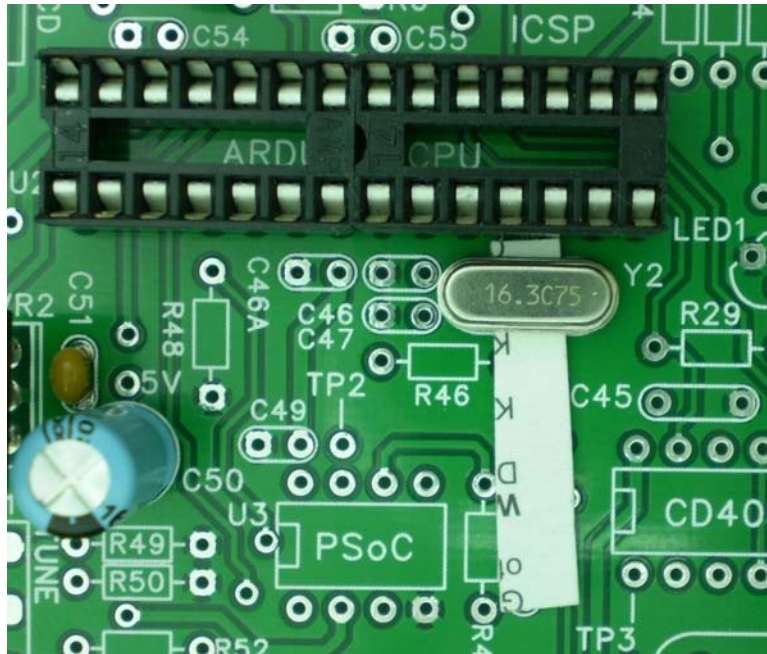

The LED is oriented such that the flat spot on the base aligns with the flat side of the silkscreen. The six pin ICSP connector must be mounted flush to the board.

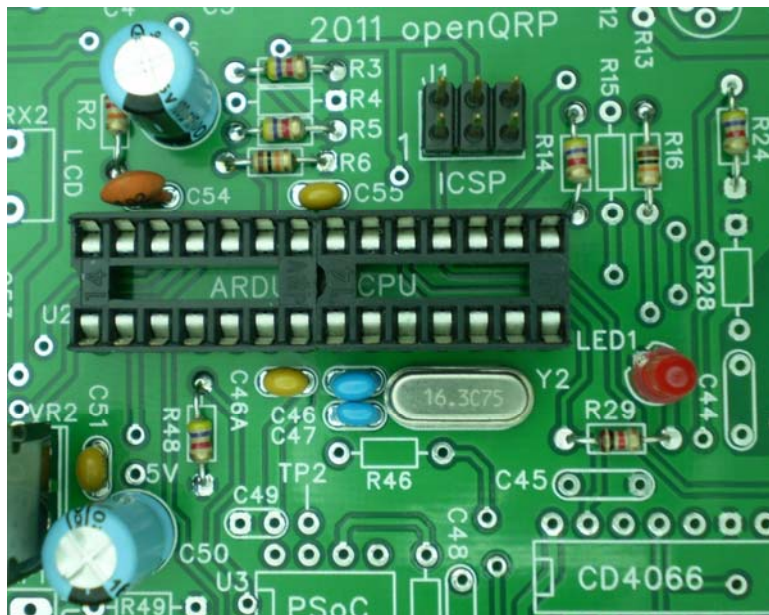

The small pushbutton switches must also be mounted flush to the PC board, perpendicular to the PCB plane. If the switches aren't mounted correctly they won't align with the enclosure front panel.

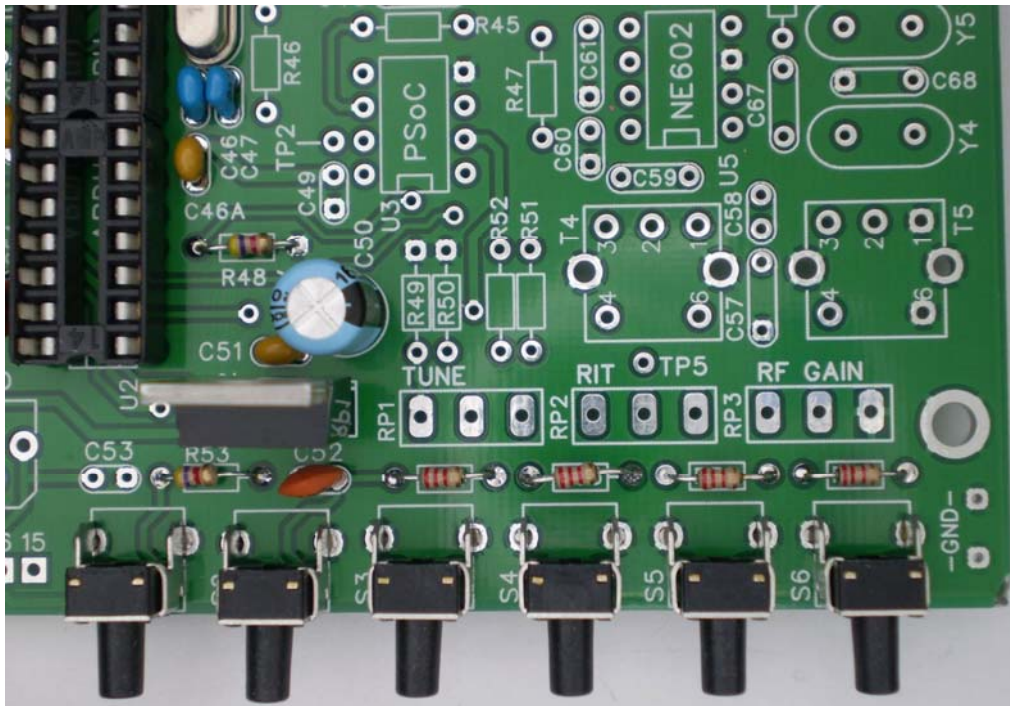

After installing all of the section 6 components, apply 12 volts to the board and then measure across pins 7 and 8 on the CPU socket to make sure you have 5 volts there. Remove power. Before installing the CPU take a look at the 28 pin CPU part. DIP ICs are shipped from the factory with their leads slightly bent out. This is done to accommodate autoinsertion machines. Before we can insert them into the board or a socket, the leads need to be straightened. Carefully bend the leads against the table until they're at a 90° angle to the body of the IC. Now you will carefully insert the CPU into its socket. Press evenly, working from end to end, watch for leads that miss, they can potentially bend under or over the socket.

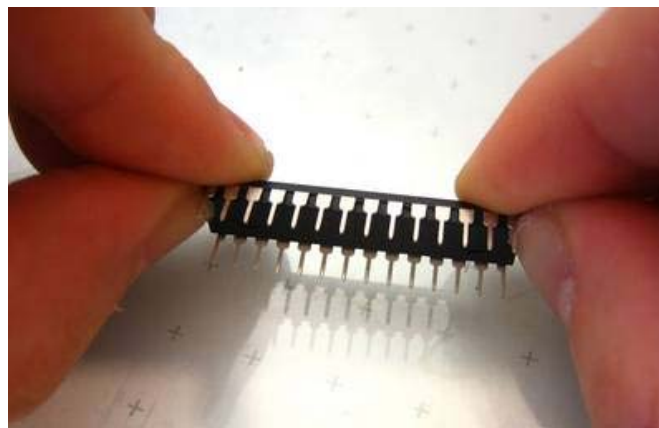

Apply power and after about 5 seconds you will see the LED flash twice and then go out, this means the CPU is up and running. Press pushbutton C/1 followed by S2 and you will see the LED toggle on and off each time. (This is the RIT enable line).

For the next test, plug a paddle set into J4. When you key you will see a square wave sidetone produced on pin 5 of the CPU. If you don't have a scope you can measure this with a multimeter set to AC. You will see an AC voltage, somewhere around 2 to 3 volts, switch on and off in time with the CW being entered on the paddles.

## Section 7 - LCD Display

This is a complicated procedure, it is crucial that the display is installed properly so that it is centered vertically in the enclosure display window. Start by installing a .1 uF cap at C53.

Solder the right angle header on the display, exactly as shown. Be aware that the paperlike thin film interconnect on the display module is delicate AND WILL BURN if your soldering iron comes in contact with it. There are plastic guides on the display that make it difficult to insert the connector, if you angle the connector while putting it in place it will snap in nicely.

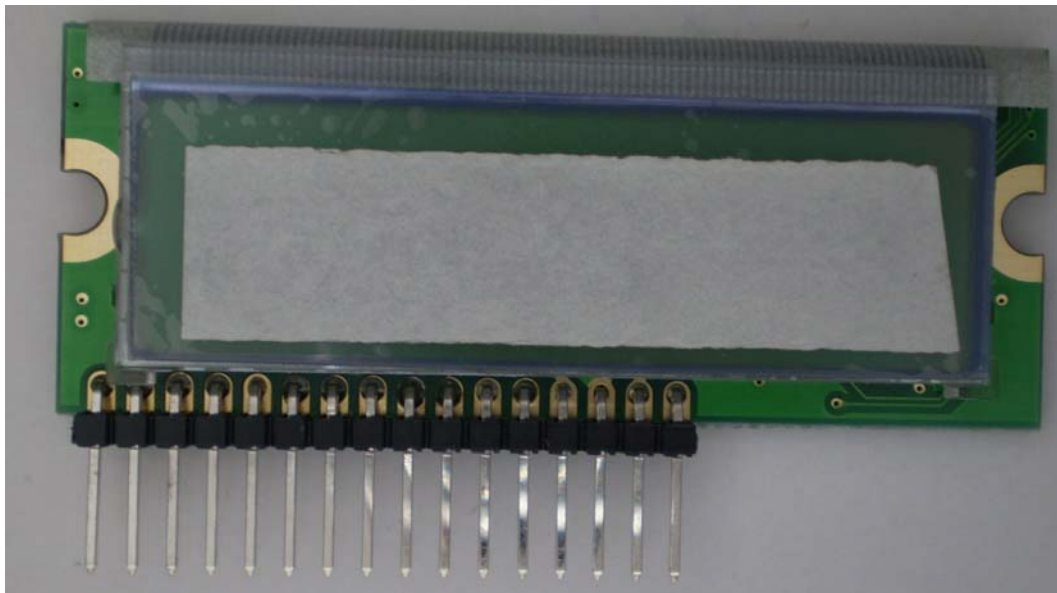

The connector must be parallel with the display as shown below:

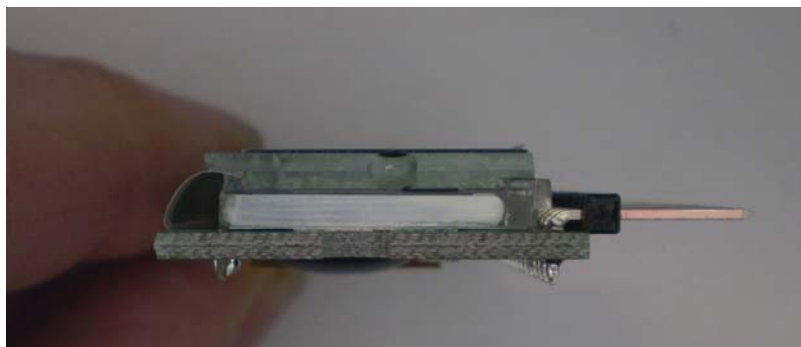

Now we will attach the display to the main board in such a way that the display is centered in the front panel opening. The connector header pins will set the horizontal alignment and we will use a cardboard guide to set the vertical alignment. The best way to do this is to cut a cardboard rectangle that is the same width of the enclosure display window. Attach the cardboard guide to the display with double side tape as shown. Leave about 1/32 inch gap between the bottom of the cardboard and the bottom of the display.

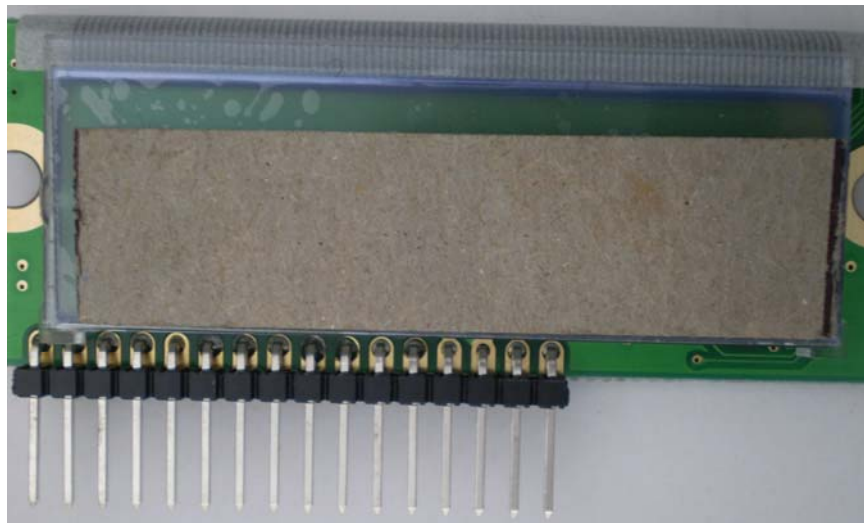
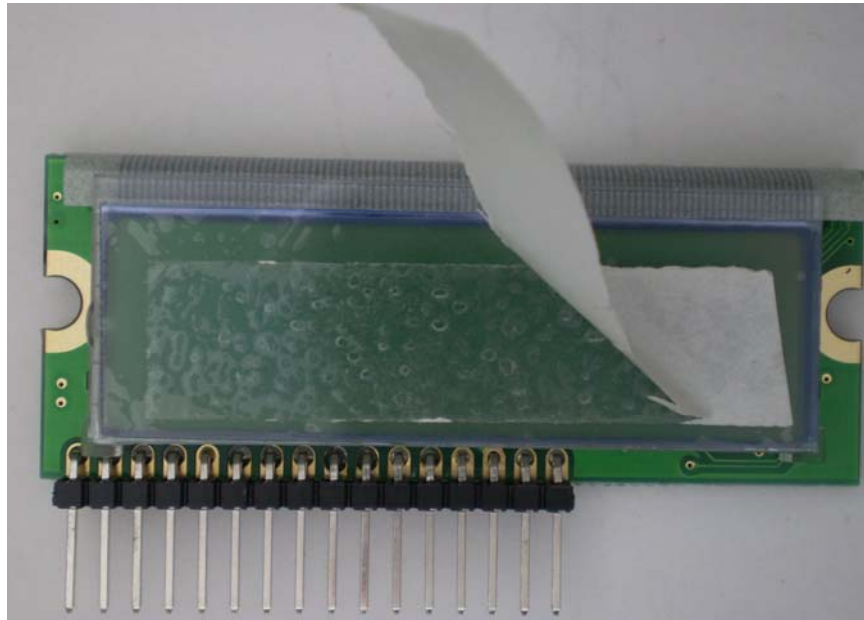

Install four rubber feet into the enclosure base, these simply press in. It helps to twist them as you put them in place.



Install the display in position on the main board and then slide the main board into place on the base enclosure. Attach the board to the enclosure with four 4-40 screws. It is essential you attach all four screws. At this time check to make sure all six pushbuttons can be actuated freely.

Now set the display so that the cardboard fits into the display window and rests evenly on the bottom of the opening.

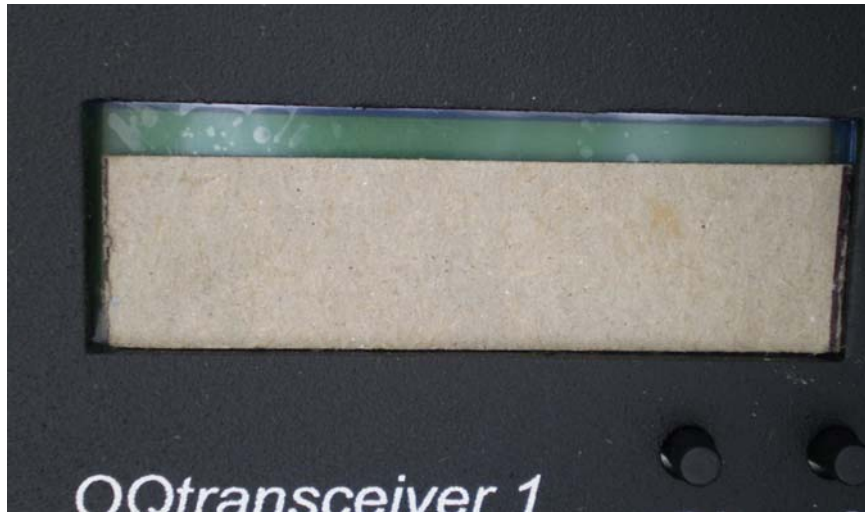

Lightly press the display forward against the front panel and tack solder pins 4 and 12 as shown, this will fix the display's position.



Now remove the assembly from the enclosure base and solder the remaining pins from the bottom of the board. For best results solder the end pins first, allow them cool, and then solder two center pins. Once those cool, solder the remaining pins. It is important to follow this sequence to prevent board warpage which will cause a misalignment of the display.

Now install the contrast control RX2, and R1. Remove the cardboard and the thin protective plastic film. Apply power and you should see the sign on display (no backlight yet).



Now that the display is installed we can try out the user interface. Granted, this will be more of a tour at this point. If you want to wait until backlight is installed that is probably a good idea since the display will then be much easier to read.

## User Interface Documentation

The openQRP transceiver firmware provides many features which can be tailored through a menu driven interface. On radio power up the following display is shown:

```
OpenQRP  REV E  
PsoC      REV C
```

This shows the firmware revisions for both the main CPU and the PsoC processor. After four seconds this display is replaced by the main operating display:

```
7012.5KHz  |||
```

The top line displays CW letters as received and decoded by the PsoC processor. If TX\_ECHO is enabled, it also displays transmitted CW as it's entered on the paddle set. The bottom line shows the current operating frequency and a relative signal strength bar graph. A colon displayed after the frequency indicates that RIT is enabled.

### Status/Quick Config Display

If you press the C/1 pushbutton and release, full radio status is displayed:

```
FvA PvB RXWPM 15  
12.5V IMB XAMQCE
```

The top line shows the F/W revisions followed by the current received CW speed. The bottom line shows the input supply voltage followed by keyer mode and currently selected options.

The keyer modes are:

**SUP** = SuperCMOS keyer mode (a variation of Iambic B)

**ULT** = Ultimatic keyer mode

**ACC** = Accukeyer mode (another variation of Iambic B)

**IMA** = Curtis Iambic A mode

**KEY** = Bug / Straight key mode (keyer bypass)

The option codes are:

**X** – Paddle Swap      **A** – Autospace On      **M** – Transmit Mute

**Q** – QSK Enabled      **C** – CWR Enabled      **E** - Tx Echo on

The status display will be shown for about 2.5 seconds. It can be cancelled sooner by pressing PB C/1. While the status display is up, there are several quick actions you can do:

1: If you press the paddle set, you can increase or decrease transmit sending speed. As you change the speed, it will be displayed on the top status line in place of the RxWPM status. The radio will return to normal operation after you stop paddling for 1.5 seconds.

2: If you press PB2, RIT will be toggled off/on. When on a : will be shown after the frequency.

3: Press PB3, PB4, or PB5 to scroll back through the last three CWR decode lines. PB3 is left most, PB4 the middle, and PB5 is right most. Exit this display mode with a PB C/1 press.

4: If you press PB6, the rig goes into Tune mode, a constant key down state. Tune can be cancelled with a press of C/1 or it will automatically cancel after 6 seconds

## Full Configuration Display

If you press and hold the C/1 pushbutton for about 3 seconds, the radio will go into config mode. The following display is shown:

```
Keyer is IAMB  
1Next 2+ 3- 4Exit
```

Initially, the currently selected keyer mode is displayed. You can change the mode by pressing pushbutton 2 or 3. To advance to the next configuration choice, press PB C/1.

Here is a list of the Configuration choices:

- 1 Keyer Mode
- 2 Paddle Swap On/Off
- 3 Autospace On/Off
- 4 Transmit Mute On/Off
- 5 QSK Mode On/Off
- 6 Backlight On/Off
- 7 CW Reader On/Off
- 8 Tx Echo On/Off

It will continue to cycle to the next config setting everytime PB C/1 is pressed. Adjust the setting with either PB2 or PB3. When you want to return to normal operation mode, press pushbutton 4.

## Stored CW Messages

There are five message slots that are sent by pressing one of five pushbuttons (PB2 thru PB6). To load a message slot, press and hold one of the message PBs until you see "Load Message" displayed. At this point you can go ahead and directly enter a message on the paddles. When you are done, press the C/1 PB to store the message. The message load feature is quite primitive, but it does allow backspace by entering the Morse sequence: <dit dit dah dah>. A shortcut to end a message load is <dit dah dit dah>. It's preferable to use this exit method since it prevents an extra space from being added to the end of the message.

## Radio Setup Mode

A radio setup mode is included in the firmware. To enter setup mode, turn power off and then press and hold pushbutton C/1 while you turn power back on. When you see Setup displayed on the top row, release the pushbutton to activate the mode.

The following display will be shown:

```
Setup  
7023.1Khz
```

There are five setup options as described below:

- 1 PB C/1: Exit setup mode
- 2 PB2: Frequency calibrate: decrement displayed frequency

- 3 PB3: Frequency calibrate: increment displayed frequency
- 4 PB4: Turn on 690Hz audio reference Hz tone (sidetone)
- 5 Reserved for future use
- 6 PB6: Toggle Key transmitter with sidetone and mute off

Frequency calibration allows the radio's frequency display to be trimmed to a known frequency standard. There are two ways to accomplish this:

1. Zero beat the OQ radio to a calibrated frequency reference.
2. Key the transmitter and then zero beat that signal on a calibrated receiver.

Once you have a reference frequency use the increment/decrement controls to set the OQ frequency display to match the reference.

The audio reference tone is very useful. First of all, it is used to set the receiver BFO. Tune in a carrier to match the reference tone and then adjust the BFO trimmer cap such that you get the strongest reading on the S meter. This involves retuning the main tuning everytime you adjust the BFO until you get the loudest signal that matches the reference tone.

Being able to key the transmitter without sidetone allows you to hear the actual transmitted beat frequency. This makes it very easy to set the Tx offset trimmer. Key the transmitter and then trim the offset to match the reference tone (which can be turned on while the Tx is keyed). Be careful not to leave the transmitter keyed for too long. Ten seconds is probably the longest keyed interval you should key before allowing an equal time unkeyed for cool down.

## Section 8 - VFO

This is one of the most difficult sections of the kit. There are many caps and they all have to go in the correct place in order for the VFO to operate correctly. I like to start with winding the toroid. Use the thin copper wire (#28) and wind 37 turns evenly spaced around the toroid. Trim the ends down to about 1/2 inch on one side and about 1.5 inches on the other. Carefully scrape the enamel off the ends to insure a good solder connection. If you have an impedance or LC meter, the inductance should be close to 6 uH. Set the toroid aside for now.

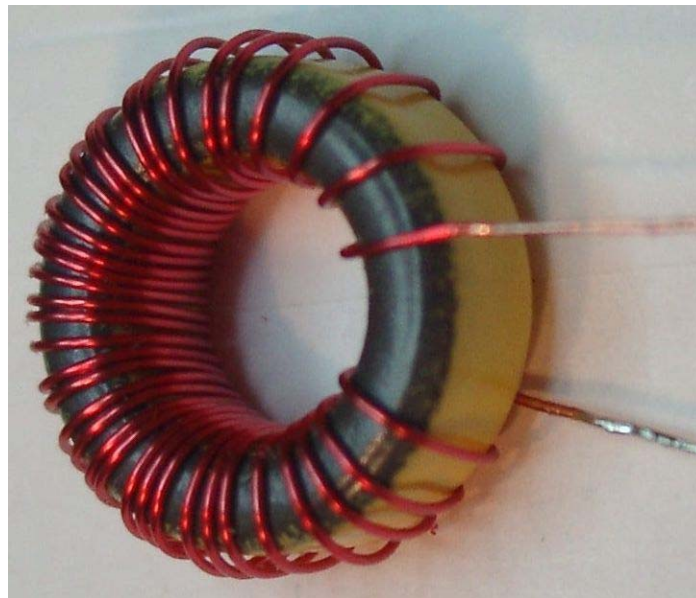

Install the various resistors and capacitors. Leave the polystyrene caps off for now. Some of the resistors, R25, R26, and R27, are mounted standing up on one end, they have a natural tendency to tilt to one side as you solder them, prevent this if you can.

Take a few moments and compare the polystyrene caps to the silkscreen. You'll find there is one orientation that fits best. Install them so they stand up perpendicularly, this will give you room to install all three.



Now we will test the VFO by temporarily tack soldering the toroid on the bottom of the board. Use solder pads that connect to the toroid mounting holes as shown below (NOT the toroid holes themselves). Power up the board and check that the VFO is oscillating. If you have a scope, look at TP4 and you'll see a nice sine wave around 2.1 MHz. It will not be super stable since the varactor voltage is not stabilized. A general coverage receiver can substitute for the scope, tune around 2.1 MHz and you should find the VFO, you might have to touch a meter lead to TP4 to get a stronger signal.

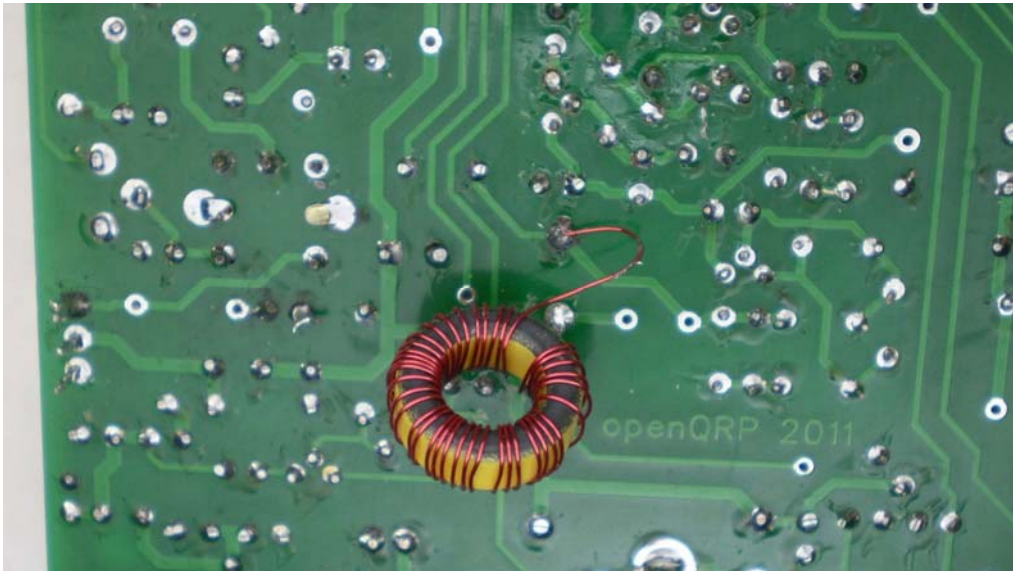

We will leave the toroid tacked on the bottom of the board for now so that we can test the VFO buffer and main tuning circuit. After installing the first section of the transmitter we will calibrate the VFO and permanently mount the toroid.

A note about CT3: I was given about 1000 of these variable caps, they are very expensive parts and are very temperature stable. The problem is adjusting them, you need a special adjusting tool. I find that trim is not essential but I left the trimmer in the kit as an option, please don't try to adjust with a metal screwdriver you'll only strip out the adjuster.

## Section 9 - VFO Buffer

This is a two transistor circuit that has two functions; it buffers the VFO before feeding the RX mixer and also squares up the waveform to a TTL logic level so that the CPU can reliably measure its frequency. With the VFO buffer in place you will now be able to view the VFO frequency on the LCD display.

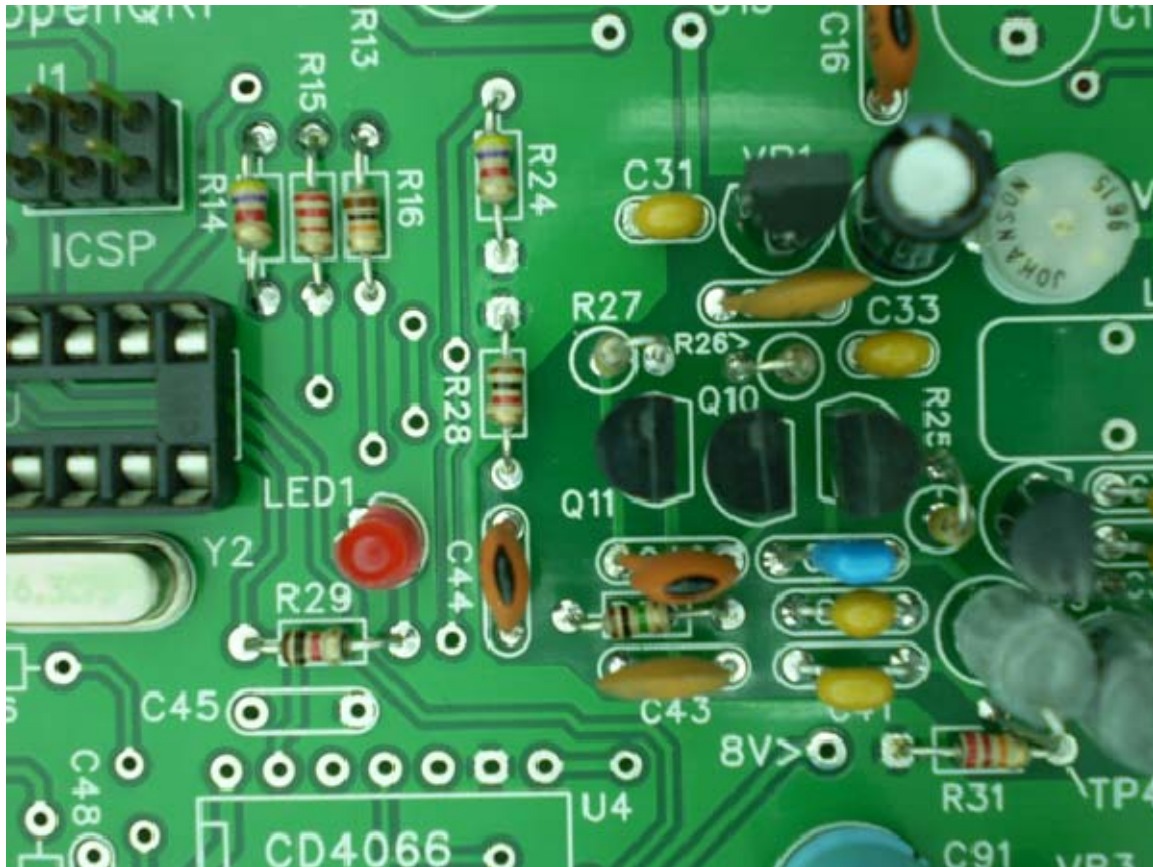

## Section 10 Tune/RIT Controls

This is a unique design that implements an RIT function with a resistance bridge. When the bridge is balanced the VFO frequency is not affected. By unbalancing the bridge we can shift the VFO offset voltage up and down. The CPU can turn RIT on and off via a CMOS switch in U4. Use care when installing the analog switch IC, U4, this part is CMOS and subject to ESD damage.

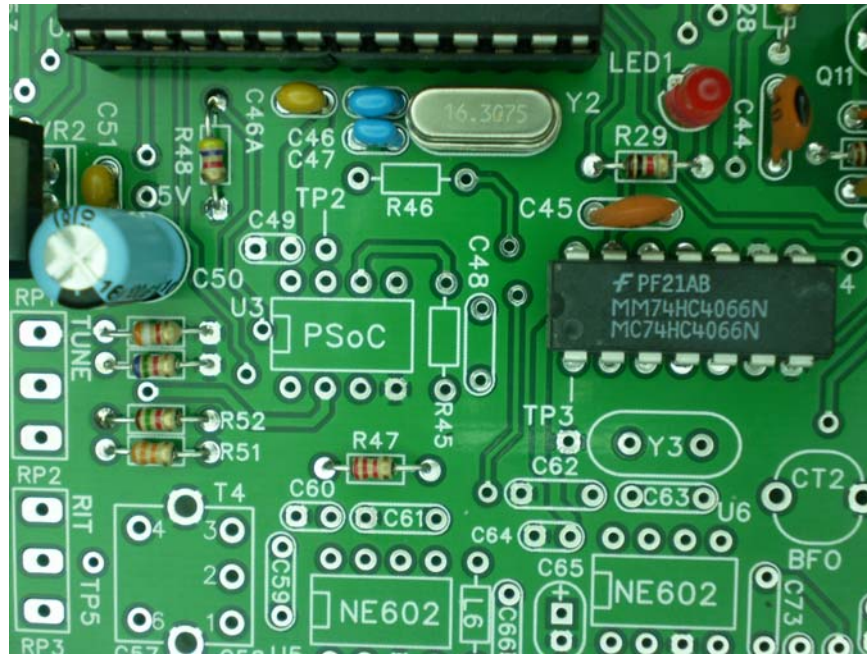

I recommend attaching the RIT single turn 10K pot to the tune pads for now. The RIT control isn't needed yet and the smaller, lighter 10K pot is easier to work with while continuing the assembly. When the tune control is attached, the VFO will stabilize and adjusting the tune control will move the VFO frequency up and down.



## Section 11 - Tx Keyed 12 V

Now we'll move to the transmitter section and install the 12 volt TX keying circuit. This allows the CPU to key the transmitter by turning on 12 volts to the transmit mixer and driver stages. It is a fairly simple assembly, consisting of two transistors and some R's and C's. The 2N7000 is a MOSFET and susceptible to ESD damage if mishandled. Straighten leads and observe polarity on C15 before inserting into the board.

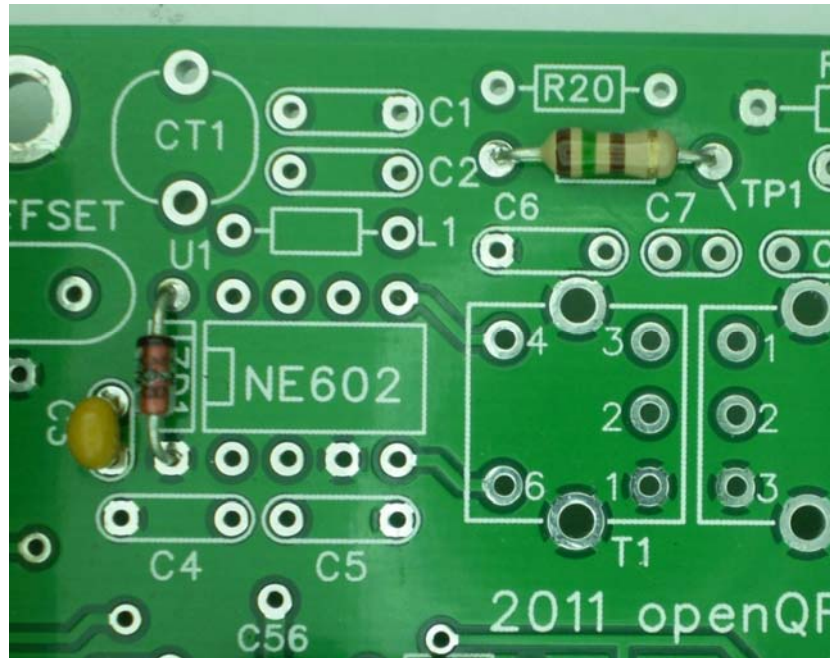

To test the circuit out you'll need to plug in a paddle set. When you press the paddles monitor TP1 with a voltmeter and you'll see the keyed 12 volt line turn on and off in time with CW dits/dahs. TP1 is next to C7, refer to the picture above.

## Section 12 - TX Mixer/1<sup>st</sup> Tx Driver

A great deal of components in this section, something to be wary of here is mixing up the ceramic caps. The tiny ones have very small printing; you'll need a magnifying glass to read them. I install the IF cans last since they get in the way of some of the other parts. Some folks like to use sockets for the 602/612s which is fine, I personally don't believe it gives you any advantage.

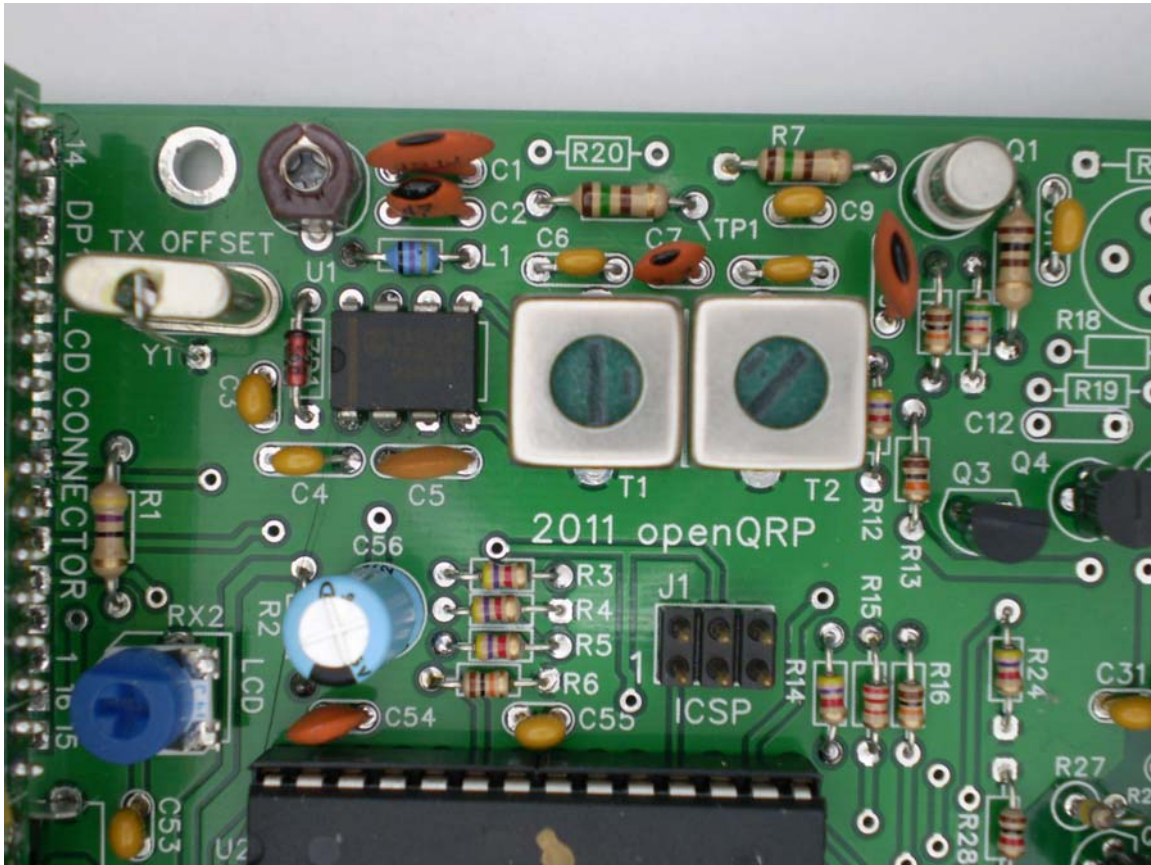

## Section 13 - PSoC Controller

This is a simple install, a socket, a couple of caps, and a resistor. We are installing it now because the LCD backlight is controlled by a pin on the PsoC and the display is much easier to see when we can turn backlight on. There are two .1 uF caps, C48 and C49, one mylar and one ceramic which are very different in appearance. Install the PsoC IC (CY872143) and then power up the radio. When the PSoC is working properly, the main CPU will detect it and display the PSoC version in the power up display.

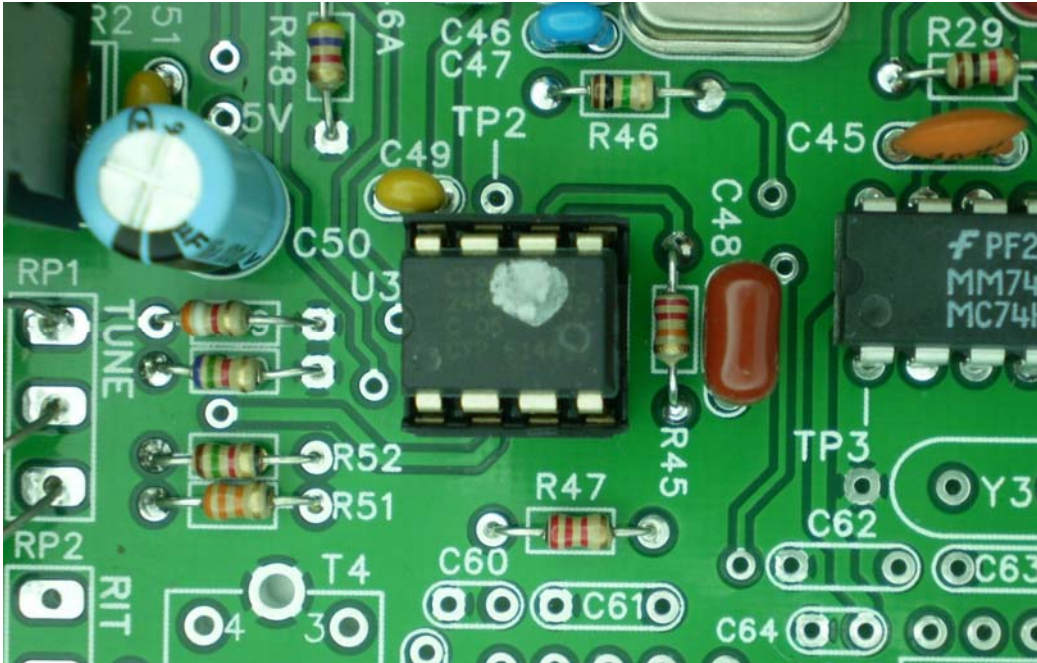

Here's the LCD sign on display with the PsoC IC installed. Note that the firmware revisions for both the main CPU and the PsoC are shown, the current revision will be different than these. Backlight can be turned on and off by a selection in the configuration menu.

## VFO Calibration

Now that the TX mixer is in place, the VFO is operating into its full capacitive load and can be calibrated and completed. We will use the frequency counter on the LCD display and then verify the reading using a frequency counter or an accurate general coverage receiver.

The VFO toroid is still tacked on the bottom of the board from Section 7. Power up the board and you will see the VFO frequency displayed on the bottom line of the LCD. Turn the tune pot to get a minimum frequency reading. It should read right around 7 MHz, odds are you will have to adjust the VFO toroid either by squeezing turns together or spreading them apart. If it's really off, remove windings to raise the frequency or add more windings to lower it. If it's very far off (less than 6.6 MHz or greater than 7.4 MHz) you may have a VFO component misplaced or you miscounted the turns on the toroid. If you don't get any reading on the LCD, recheck the VFO buffer components. If it's working correctly, you'll see a square wave on pin 11 of the CPU with a peak amplitude of 2.8 to 3.3V

Once you get the VFO on frequency, advance the tune pot to check the high end frequency, it should go up above 7.060 KHz. Now we will permanently mount the VFO toroid. First unsolder the toroid from the bottom of the board and trim the leads to about ¼ inch. Carefully scrape and tin the ends. Next fix the two ends of the windings with a little bit of clear fingernail polish or airplane dope. Don't coat the whole thing, just do 2 or 3 windings on each end, this will allow us to move the top most windings as part of final calibration.



After it dries put a small dab of RTV glue on the bottom of the toroid and put it in place, threading its leads through the PCB mounting holes. Place the toroid so it sits upright and perpendicular to the board, the wire leads should be pulled relatively tight and then soldered. Now verify the VFO still works and then leave it alone until the glue dries.



After the glue has dried completely, turn on power and set the tune pot to the low end of the band. You will find that the frequency has moved slightly due to the added capacitance of the toroid being close to the PCB. You can tweak the frequency by adjusting the spacing between the turns on the toroid. I like to settle on a low end frequency just slightly below the band edge, somewhere close to 6.997 MHz. Once you are happy with the calibration set the upper portion of the windings with fingernail polish or airplane dope.

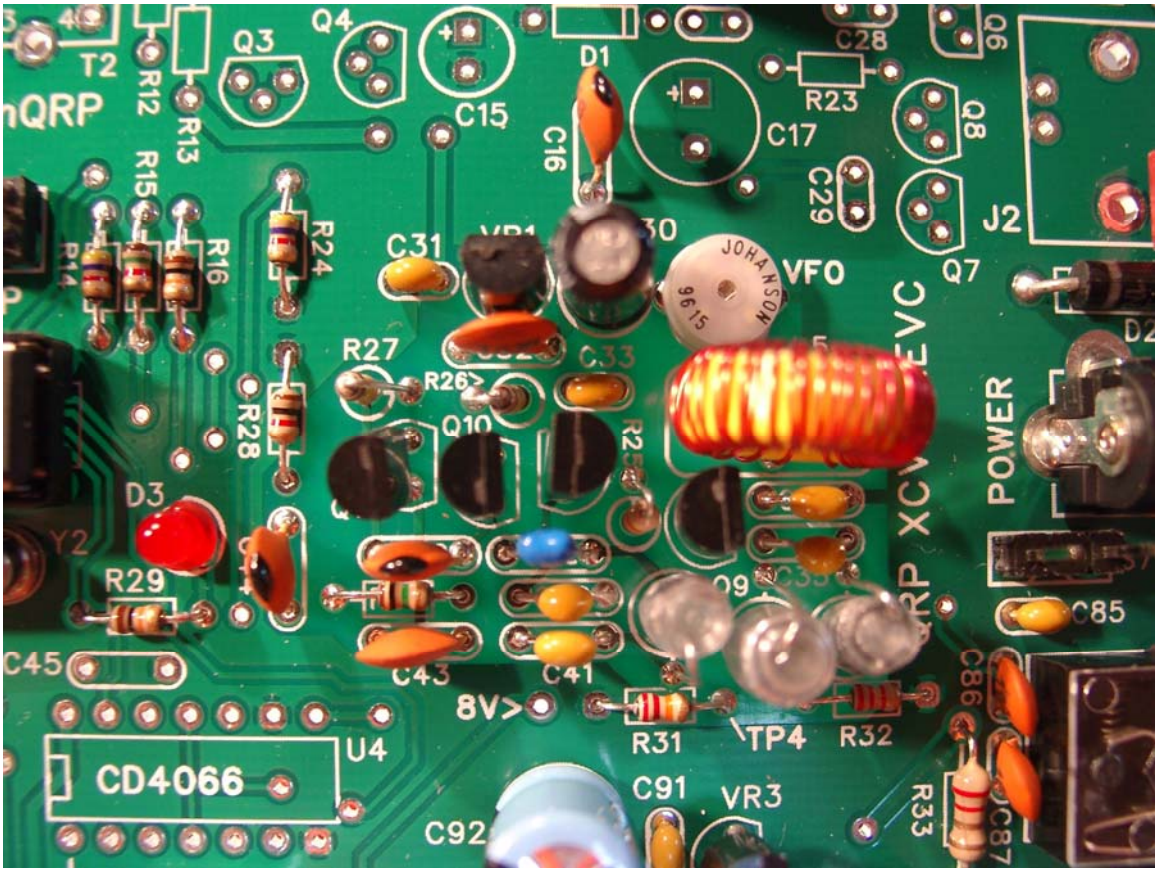

Completed VFO !

## Checkout of the Transmit Mixer

Fully unwind the two IF can (T1 and T2) slugs counterclockwise, just turn the slugs until they become snug, don't force them beyond that. Now set the frequency to about 7.030MHz and then check the VFO injection level, you should see about 200-250 mV at pin 1 of U1.

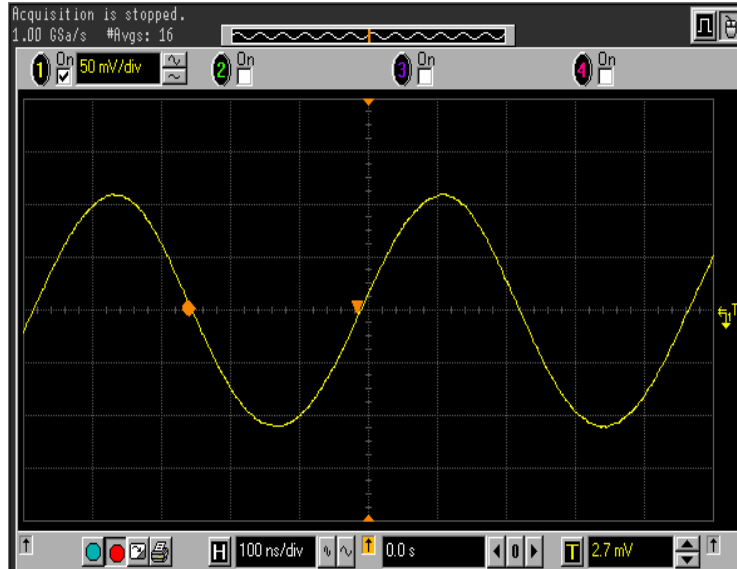

VFO Injection into the transmit mixer, pin 1 - AC Coupled, 200 mV PtP

The next set of tests can only be performed while the transmitter is keyed, you can either do this by using Tune mode (press C/1 followed by PB6) or preferably set the keyer to straight key mode and then you can key by pressing and holding one of the paddles. With the transmitter keyed you should see these waveforms on U1:

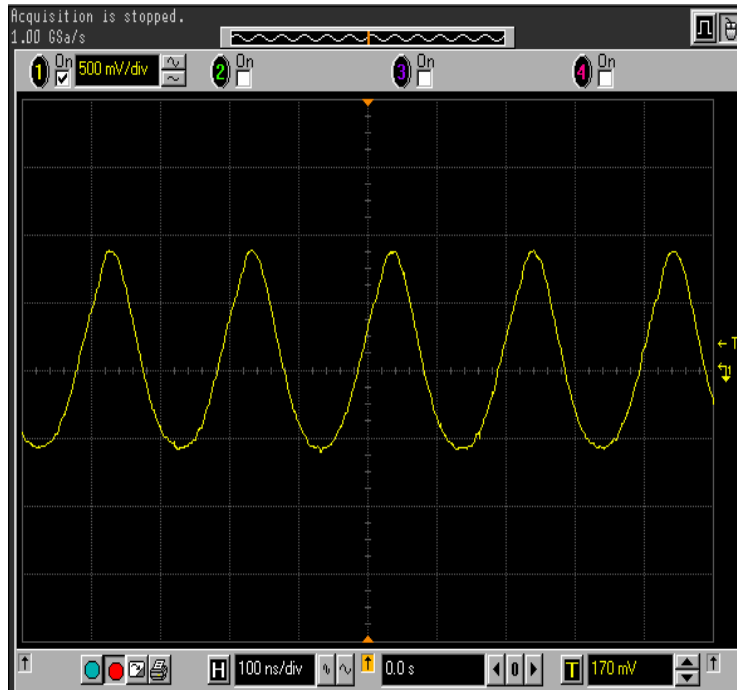

**Tx Mixer, crystal oscillator pin 6 - AC Coupled, 1.5V PtP**

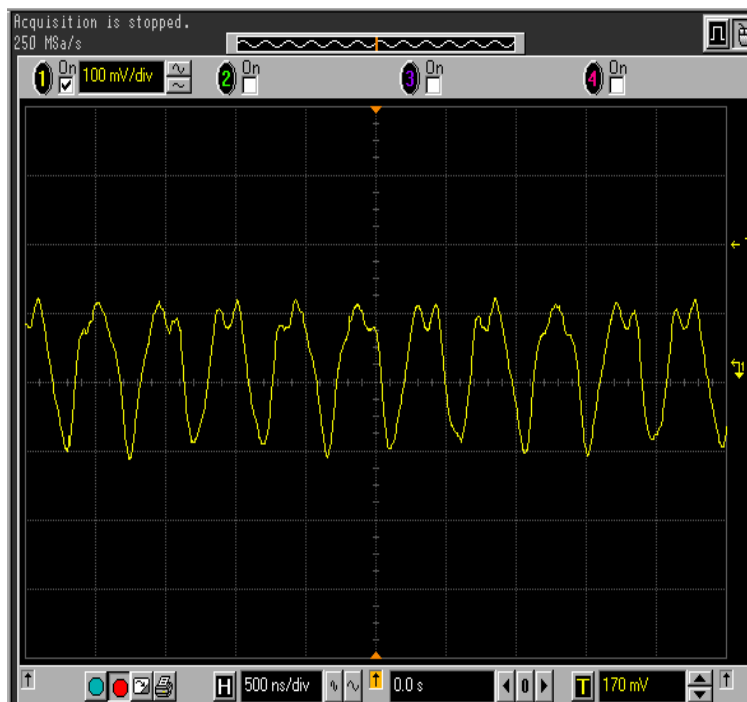

**Tx Mixer Output, Pin 4 (pin 5 should be similar) - AC Coupled, 200 mV PtP**

Now monitor the waveform at the collector of Q1 via C11 (scope or RF probe). Turn T1 and T2 slugs clockwise, a little bit at a time until you get a good strong peak, you may find a smaller false peak before you get to the true peak. The two adjustments affect each other so there will be a bit of back and forth. The correct peak will be in the 7 MHz range. If you don't have a scope or RF probe, an alternative is a ham band receiver with an S meter. The output of the driver is in the 7MHz band so you should be able to find it and peak it with the receiver's S meter. The peaking adjustments are just preliminary at this point. After the Tx driver is installed we'll have to go back and tweak these settings again. When keyed, you should see a sinusoidal waveform, about 1.2V PtP, at the collector of Q1, the frequency will be the same as displayed on the LCD.

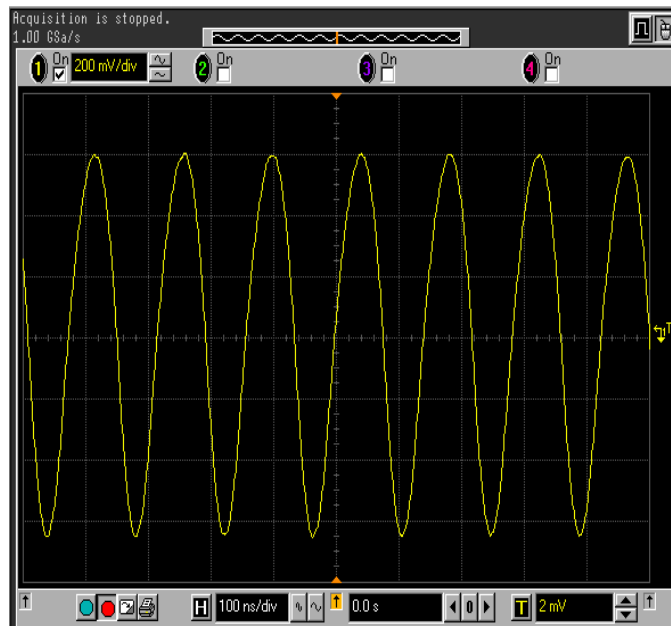

**Collector of Q1 - AC Coupled, 1.2V PtP**

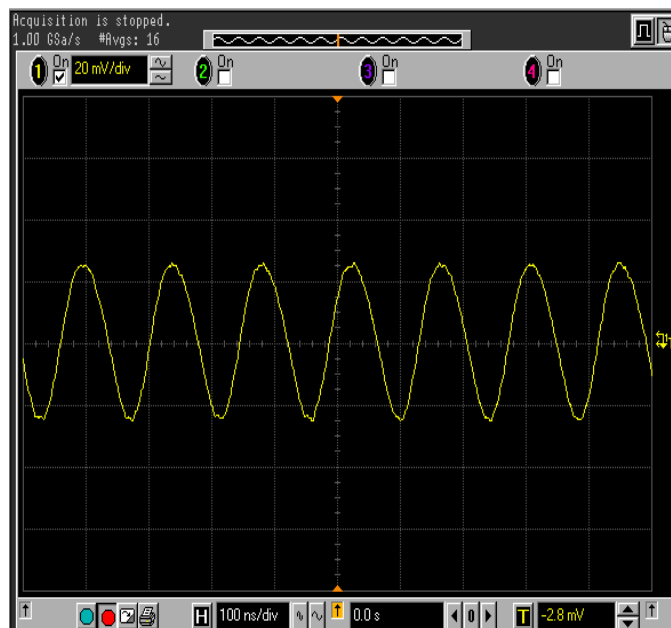

**For reference: the base of Q1**

## Section 14 - Low Pass Filter and RX Antenna Switch

### Low Pass Filter

The low pass filter consists of two toroids and six capacitors. The two T36-7 yellow core toroids are identical each having 17 turns of #24 wire. The inductance value we are looking for is 1.2 uH per inductor.



Note that the three shunt capacitors in the filter are each two capacitors in parallel. I chose a Chebychev filter topology because of its steeper roll off characteristics. The capacitor values for this type of filter do not work out to standard values so I use two caps in parallel which allows me to get very close to the design values.

The BNC connector is packaged separately, find it and install it now. Make sure the connector is properly seated on the board before soldering all four connections.

### Rx Switch

Now that we have installed the low pass filter, we will add the components that connect the receiver to the antenna. The antenna switch consists of three FETs: two 2N7000s and one ZVNL110A. Make sure you get them in the correct places. The ZVNL110A is an unusual package and easy to pick out, I decided to use this part in the Q6 position since it has a higher breakdown voltage than a 2N7000 and provides a better safety margin.

This circuit can be tested by first measuring resistances from the center pin of the RF gain control pads to ground. When transmitting, this will be switched to ground. When receiving, you will see continuity from the center RF gain pad to one side of C25. Pressing the paddle will cause the transceiver to switch between Rx and Tx.

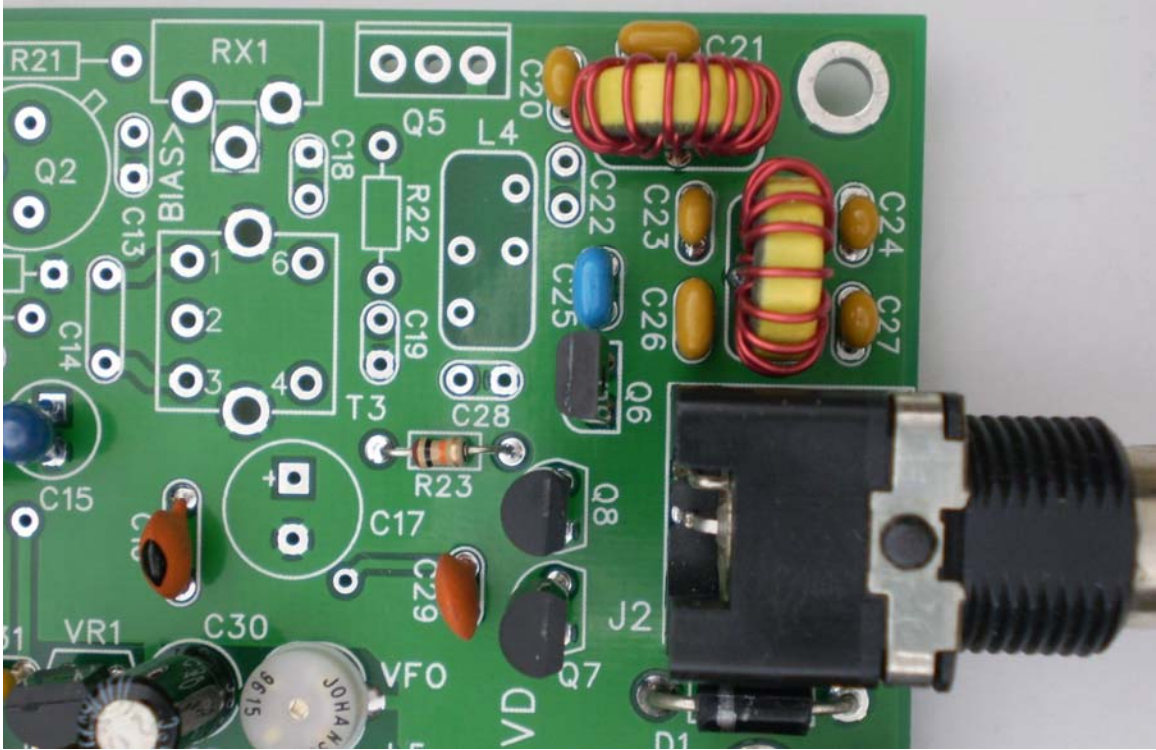

## Section 15 - Audio Amplifier

We will now work on the receiver, starting with the AF amplifier which will be useful in testing the active filter with the CPU's sidetone. Install the AF level trimmer last to allow room to get other parts installed. Placing a .01 uF cap (C94) across the audio amp output is necessary with some speakers to prevent instability. Whether you need it or not I would go ahead and install this so that you don't have to take it all apart to do it later if and when you find a set of headphones that sound raspy. Please Note: C81 is a tantalum cap, plus side toward U8. The plus sign is shown in the picture below for reference; it is not present on the silkscreen.

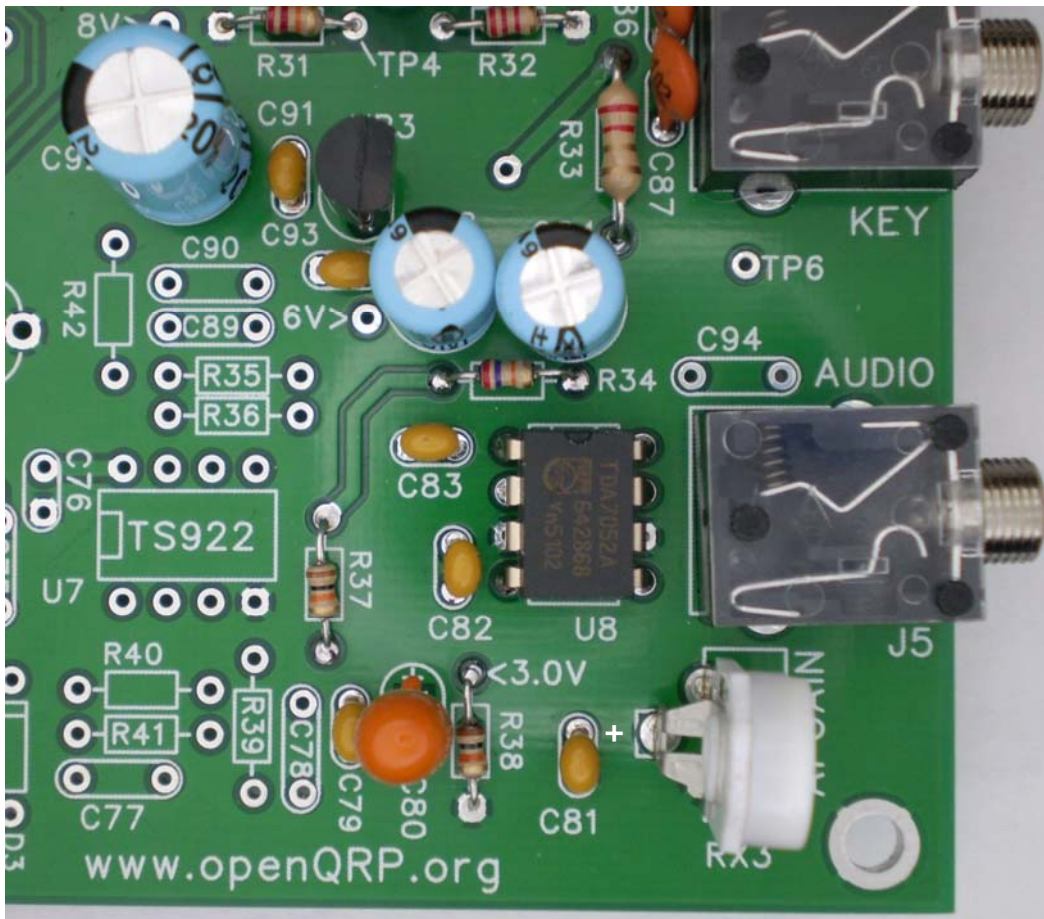

## Section 16 - Active Audio Filter

Install the TS922 op amp U7 and associated filter components in this section. The .012 uF caps are marked with a 12nJ. The three precision 1% resistors should be sorted with an ohmmeter. I find the color codes on these resistors to be very hard to read and a few extra minutes spent now will mean less grief later.

After the filter is installed, attach paddles and a speaker or headphones. Turn the AF level control fully counterclockwise. Turn on power. If everything is installed correctly, you will hear sidetone when press the paddles. Turn the AF level control clockwise to increase the volume to a comfortable level. You can adjust the sending speed by holding the command pushbutton down and pressing the paddles, left or right. As you adjust the speed, it will be displayed in the upper right hand corner of the display.

Sidetone is produced by the Arduino CPU and is fed to the input of the active filter though the analog switch U4. The CPU produces a squarewave at 690 Hz (the active filter's center frequency) which is filtered to produce a nice sounding, almost sinusoidal, sidetone.

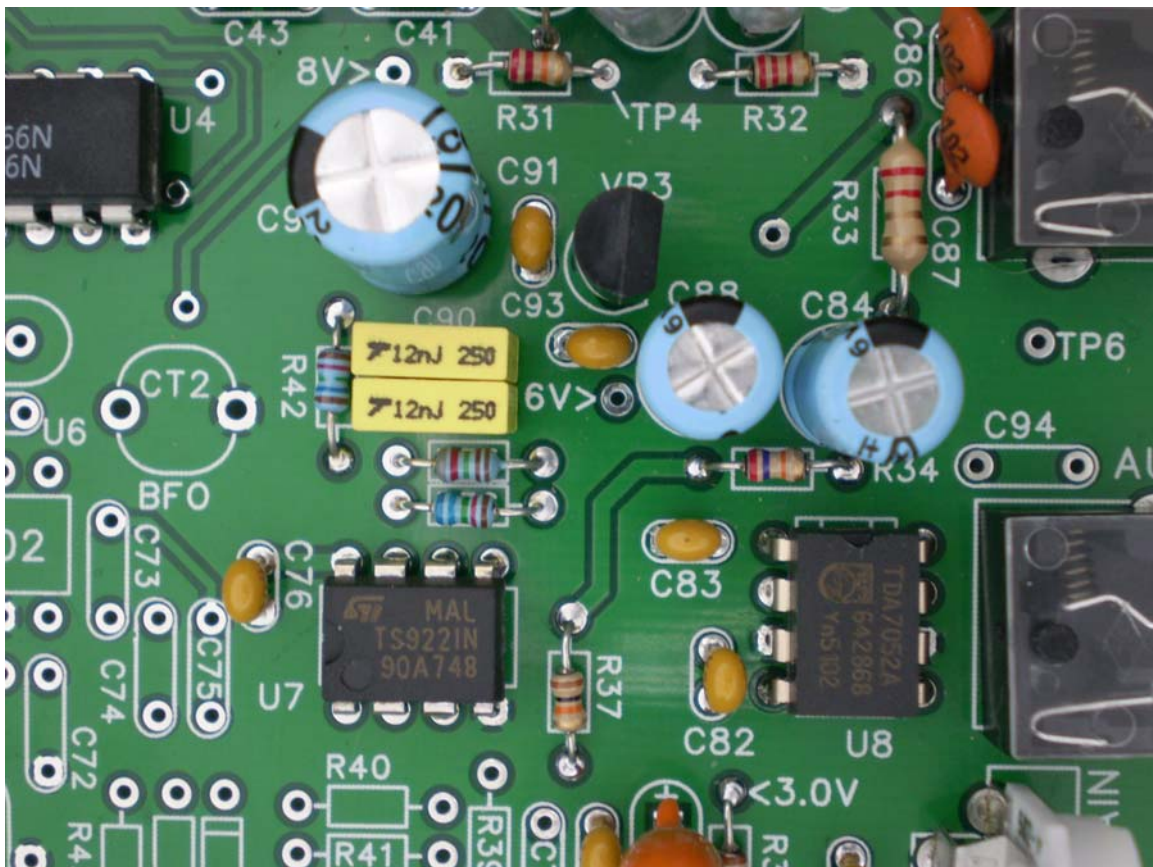

## Section 17 - RX Input Filter, 1<sup>st</sup> Mixer, Crystal Filter

The order of assembly is important here. We want to install all of the low profile parts first and then the tall parts. The parts are listed in order of assembly in two parts.

### Some helpful hints:

When installing the two IF cans, T4 and T5, make sure the cans are installed flush to the PC board. Bend the mounting tabs in to hold them in place while soldering then solder the tabs last.

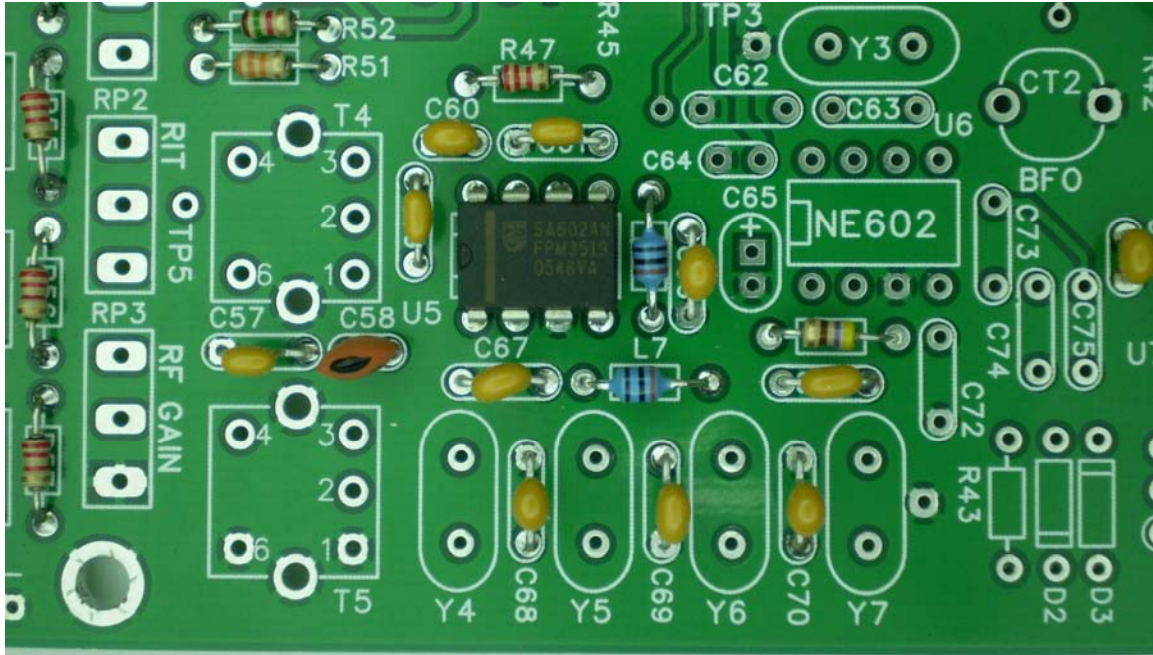

## Crystal Filter

The input matching network (C66, L6, and L7) may seem odd, why two inductors? I could not find a reliable source for 20  $\mu\text{H}$  inductors so I used two 10  $\mu\text{H}$ s in series. A side benefit is that non-standard values of inductances, as dictated by other bands, can be accommodated easily.

Install the caps in the crystal filter first, as before these are tiny parts, use a magnifying glass to be sure you install them correctly. The 39 pF is labeled 390 while the 56 pF is labeled 560. The downside here is the filter will "work" if you get the caps mixed up, but will not work well. It is very difficult to debug this if it happens. When installing the crystals use the "piece of cardboard trick" I outlined earlier in section 7. Install the four crystals so that the labeling on the side of the crystals all face the same way.

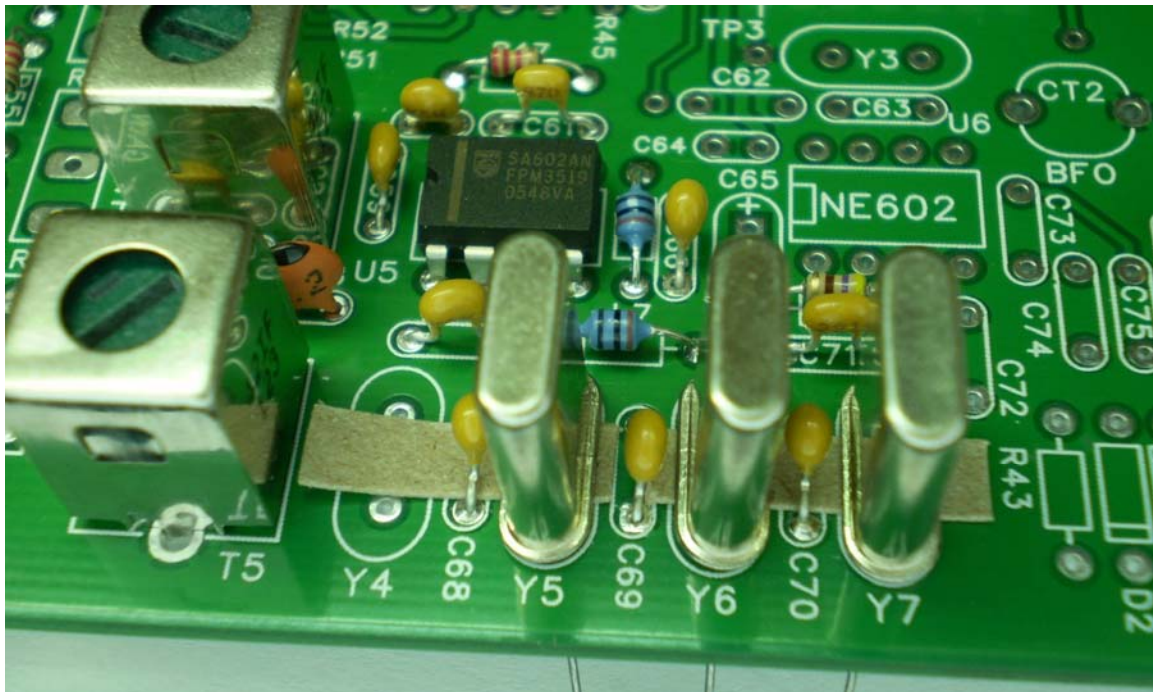

Using a thin piece of bare wire solder across the tops of the crystals and then solder the wire to the ground via provided. This prevents large amplitude, out of band signals from bleeding through the filter. Solder the wire to the crystals quickly with a tiny amount of solder to avoid damaging the crystals.

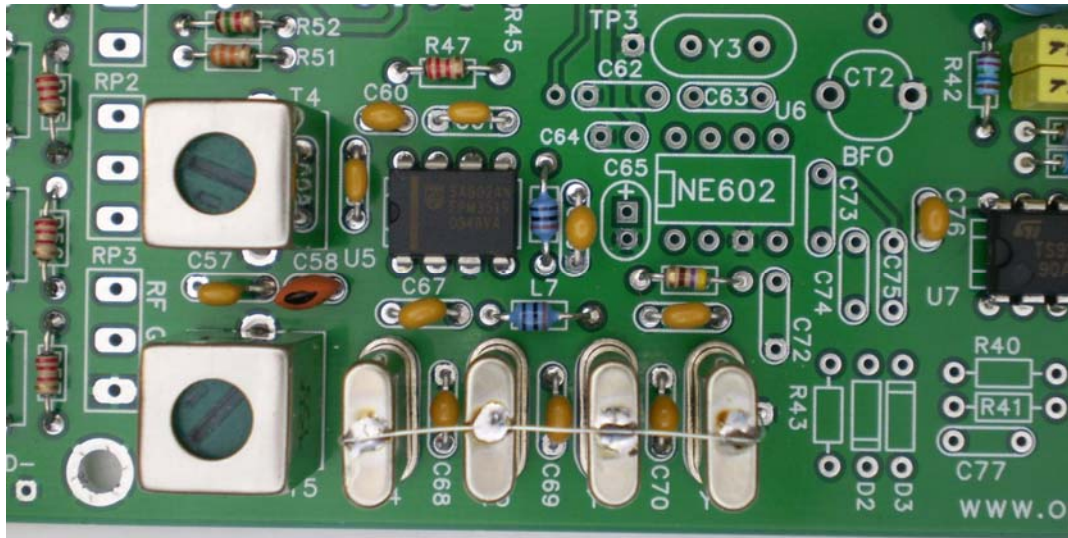

There is one PCB board error, the ground return on the second IF can is not present. To correct this we need to solder a .001uF cap on the bottom of the board as shown. This capacitor is labeled as Cxx on the schematics.

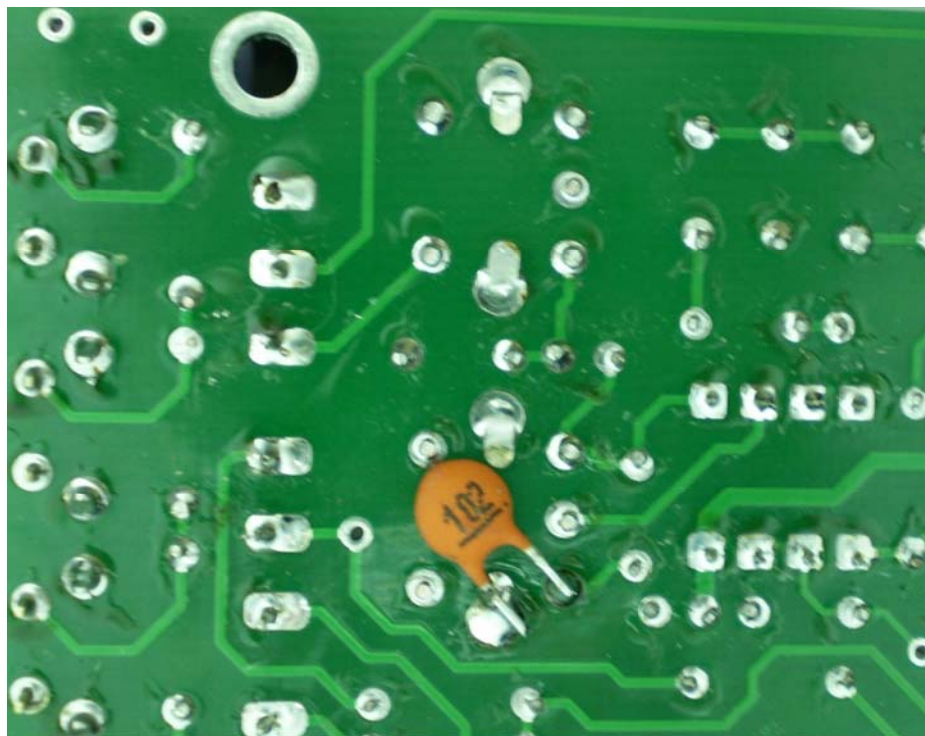

## Section 18 - 2<sup>nd</sup> RX Mixer and Differential Amplifier

This is the last piece of the receiver. There is a little bit of everything in this section; crystal, IC, small caps.... Things to be careful with:

- 1) Diodes: make sure the bands on the diodes match the silkscreen.
- 2) C73, C74, C75 are high quality mylar capacitors, avoid using noisy ceramic caps here.

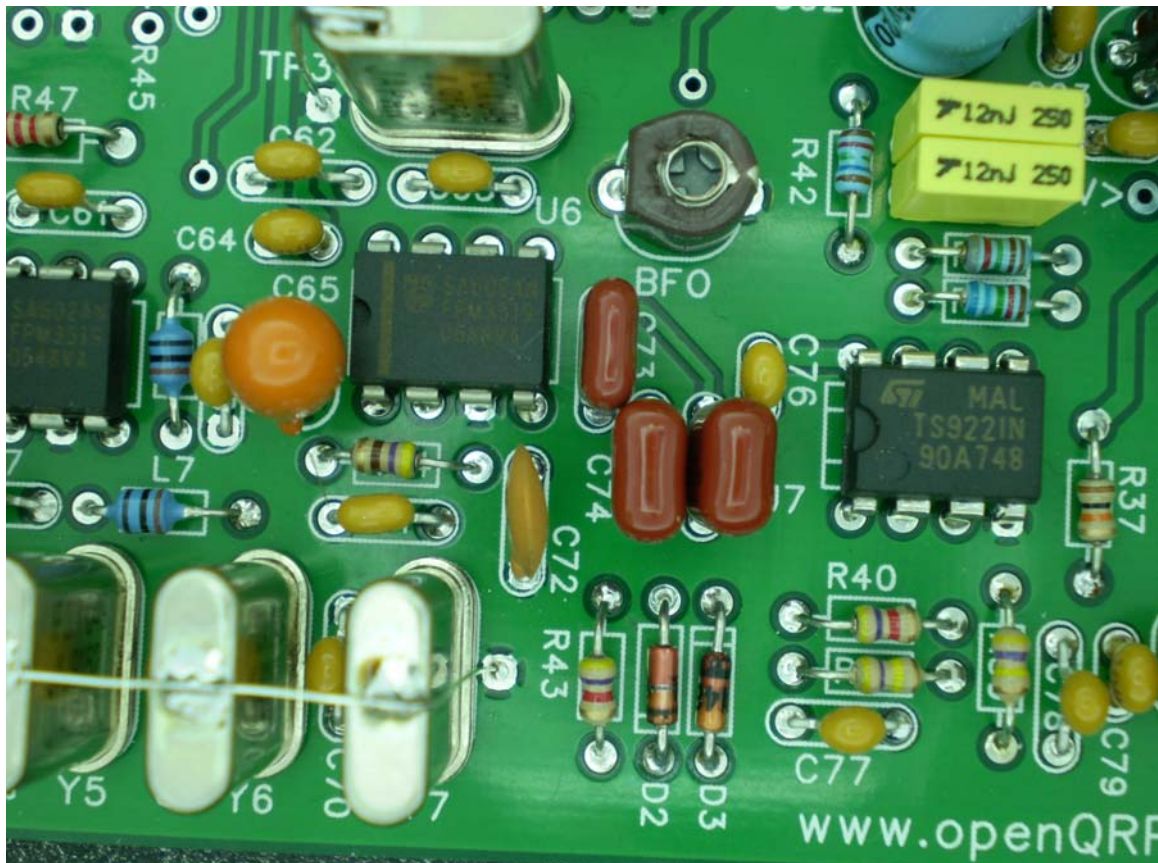

This completes the receiver chain from antenna to speaker. Next step is to attach the controls and check out and align the receiver. After that we will finish installing the transmitter.

## Install Tune, RIT, and RF Gain Controls. Rx Checkout

If you had installed the RIT POT as the tune control, now is the time to connect the ten turn pot instead. The illustration below shows how to connect the three controls to the PC board.

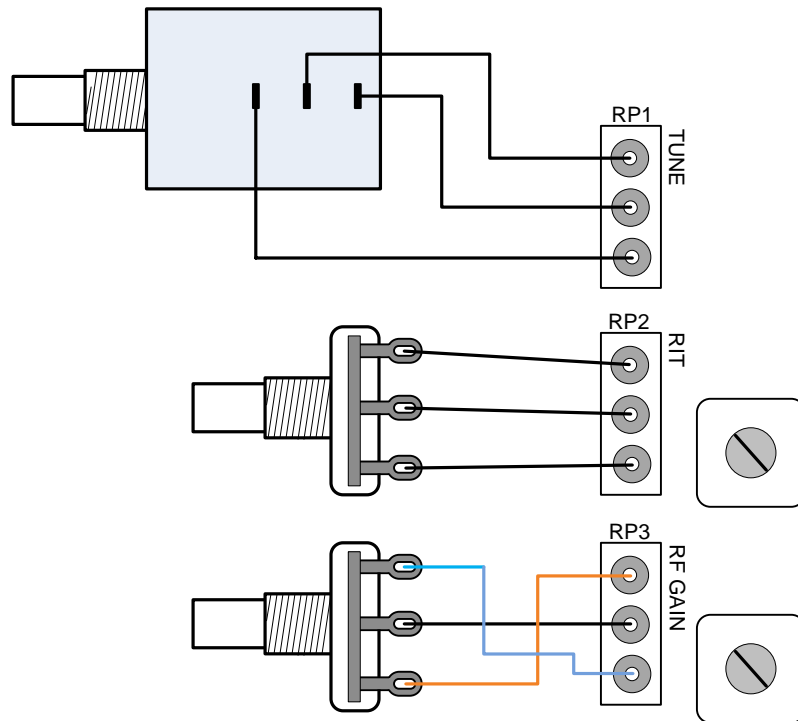

The wire length for each control is as follows:

Tune Pot: Three 6 inch wires

RIT Pot: Three 5 inch wires.

RF Gain Pot: Three 4 inch wires.

The best way to do this is to strip the ends of the wires, tin them and then install them in the PCB board. Then attach the wires to the controls. Do one control at a time. You will need to break off the alignment pin on the two single turn pots so that they will mount correctly on the front panel.

### Receiver Alignment Procedure

Attach a speaker/headphones and antenna and then power on the transceiver. Adjust T4 and T5 for a peak noise level. Adjust the AF level control up or down to suit your taste. You will need some sort of RF signal source, set it to something in the 40M CW band, 7030 KHz is good. Now tune the OQ transceiver to that frequency and you should hear the signal. Re-check the peak adjustment on T4 and T5.

Before adjusting the BFO (CT2) it is helpful to review how the receiver works:

Incoming signals from the antenna pass through the T4 and T5 tuned circuits and are then fed into the first mixer. Here the incoming signal is mixed with the VFO to produce a signal at the IF frequency (4.9152 MHz). This frequency is in the center of the crystal filter passband. Beyond T4 and T5 there is no other adjustment for the first mixer and crystal filter. After the crystal filter, signals are fed into the 2nd mixer which mixes the IF with a 4.9152 MHz crystal that can be pulled off frequency by CT2. When the offset crystal frequency and the IF are mixed, the result will be an audio frequency. The goal is to adjust CT2 so that this audio frequency is 690 Hz, the center frequency of the active filter.

Adjustment of CT2 requires a bit of back and forth between the Tune control and CT2 such that the incoming test signal is in the center of the crystal passband *AND* CT2 is adjusted to produce a difference frequency that is right in the middle of the active filter. If you have a scope you can look at the output of the active filter (pin 7 of U7) to get a better idea of peak. Or you can use the bar graph on the LCD display. A reference tone is provided in the radio setup, this is described on page 12. Essentially you match the Rx beat note to the reference tone to be sure you are in the center of the passband, then you adjust Tune and CT2 until both tones match with maximum bar graph deflection. This takes a bit of patience to get it set up correctly.

### **PSoC & CWR Test**

The PSoC runs continuously and has two main tasks. The first is to look for signals in the receiver's 690 Hz passband and show a relative strength indication on a bar graph in the lower right hand corner of the LCD display. The second task is to decode CW, either sent on the paddles or coming in from the receiver, and display it on the top line of the LCD display.

At this point you will have aligned the receiver and should be able to tune in CW stations. To decode incoming Morse, simply tune in the signal for maximum deflection on the bar graph and after a letter or two the PsoC will lock on and decoded letters will be displayed. Press the C/1 button to view the received CW speed in the status window.

A couple of side notes, the PSoC CWR does a pretty good job overall but has a couple of limitations. It really can't decode improperly spaced letters very well. If letters are run together, the CWR will not be able to distinguish between them. Also, large background noise amplitude makes copy very difficult and can cause the CW to lose sync for a letter or two. The CWR requires a fairly strong signal to operate well. Even though you may hear the signal, if it doesn't cause much of a deflection in the bar graph display the CWR will ignore it.

### **Section 19 – Part 1: 2<sup>nd</sup> TX Driver**

We will now install Q5 before the remaining parts of the transmitter. This involves aligning Q5 with the heatsink bracket so it's important to follow the directions carefully. First of all, mount the bracket to the chassis base plate with one 4-40 screw as shown below.



Snap heatsink insulator in place:

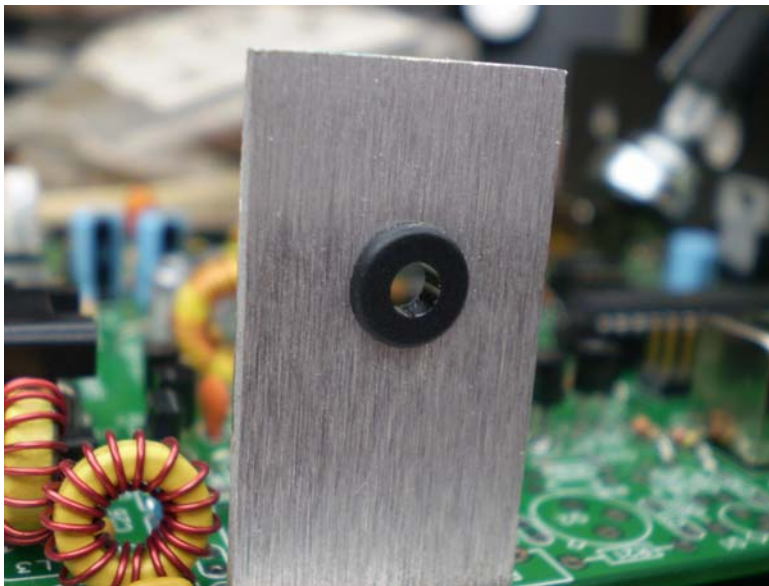

Now attach the PC board to the chassis with all four screws:

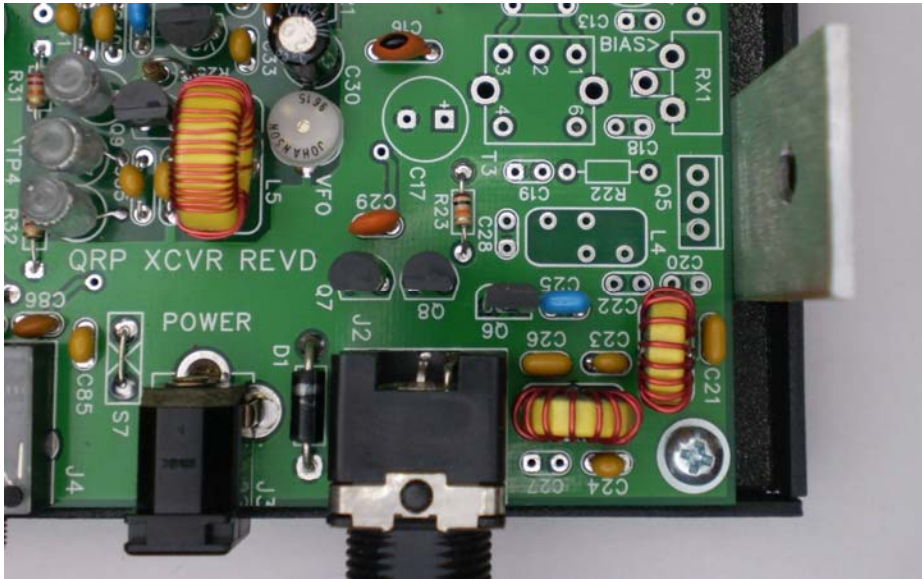

Place Q5 (IRF510) in PCB location Q5 and then attach it to the heatsink with a 4-40 screw and nut using the picture below as a guide:

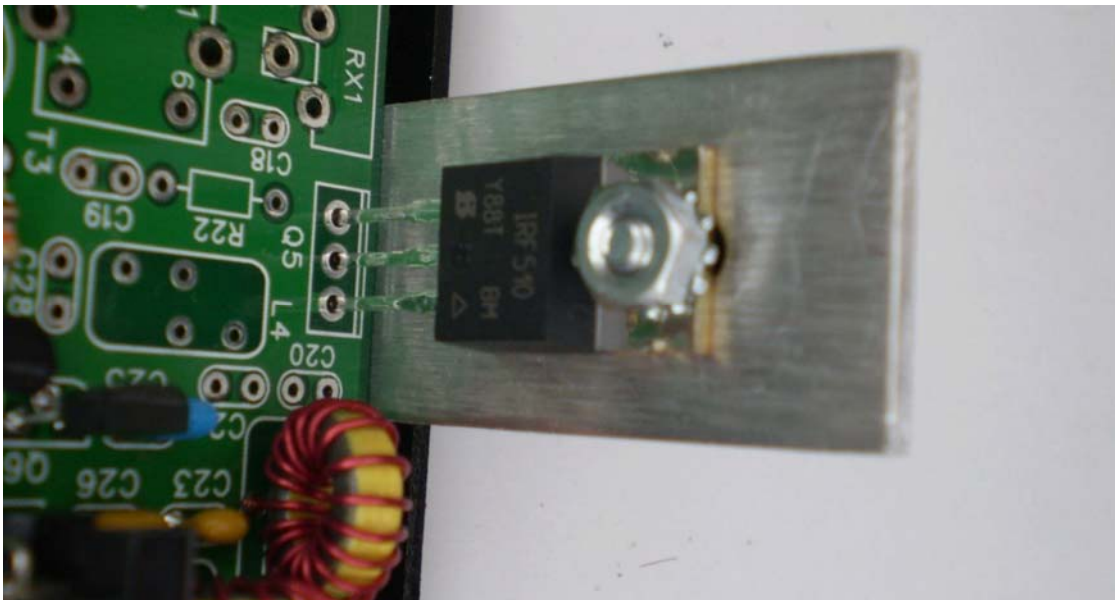

Now that Q5 is in place carefully solder the two side leads from the top of the PC board. This fixes Q5 in place.

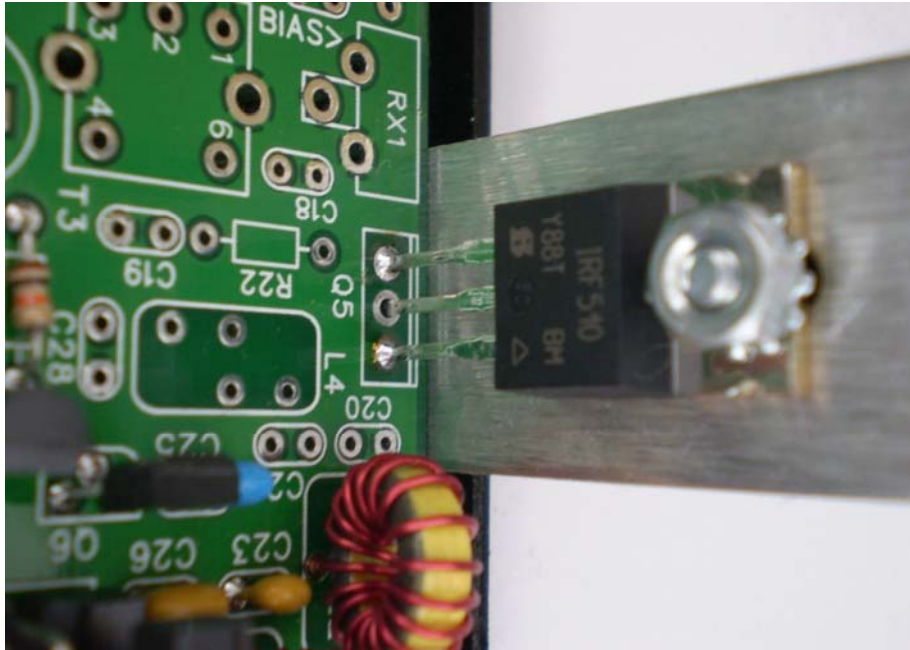

Now detach Q5 from the heatsink, remove the PC board from the chassis base, and then solder the middle connection of Q5 from the bottom of the board. Now we can proceed with the rest of the transmitter assembly. Install all parts of section 19 except L4. We want to be able to test the driver stages without activating the MOSFET final. That way we will prevent damage to Q5 in the event there is some sort of problem. It also allows us to safely preset the gate bias to a reasonable starting value.





We can test the Tx driver by looking at the collector of Q2 while keying. The collector of Q2 is connected to the case of the transistor which makes a very convenient test point. There is no point trying to peak T3 now, it will not give an accurate peak. You should see about 14V PtP on Q2's collector as shown on the next page. While you have the transmitter keyed, it's a good time to set the Tx bias level. Monitor the pad of Q5 that is closest to RX1 (Q5's gate) with a voltmeter, adjust RX1 to 4.5 volts which is a good starting point. Use tune mode by pressing C/1 followed by PB6.

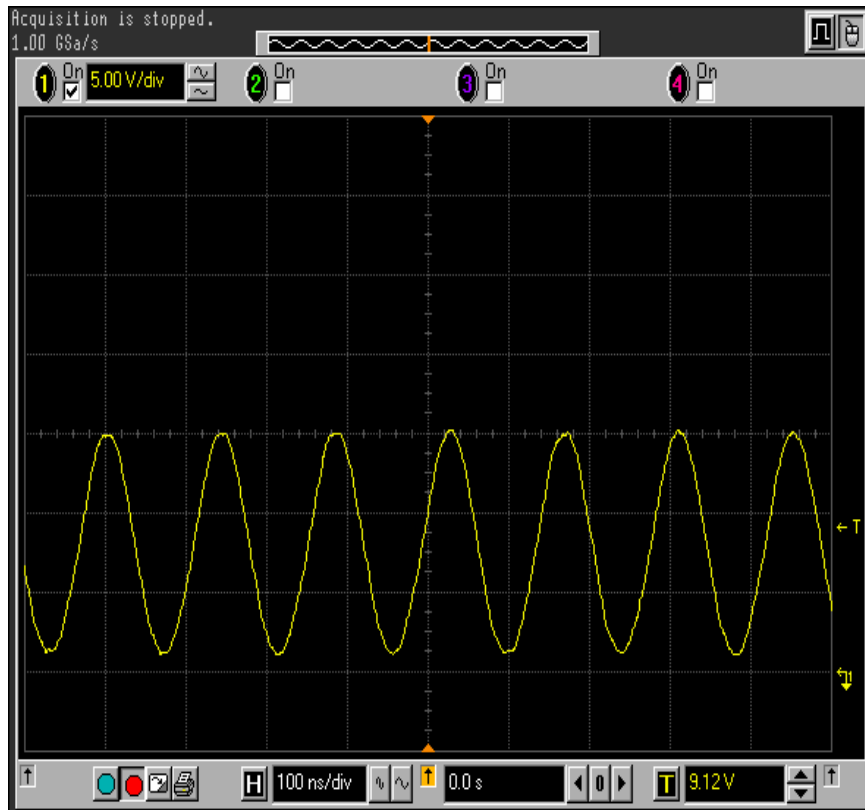

**Collector of Q2 - DC Coupled, zero reference is one division up from bottom.  
Waveform is 14 V PtP, bottom at 2 V**

## Section 21 – Tx Final Assembly and Transmitter Checkout

It's time to wind L4; it is bifilar wound and consists of 7 turns. From the remaining #24 wire cut two pieces that are the same length. Wind the toroid with the wire pair for seven turns exactly as shown in the figure below. Please don't mix up the leads; it won't work if it's not hooked up right.

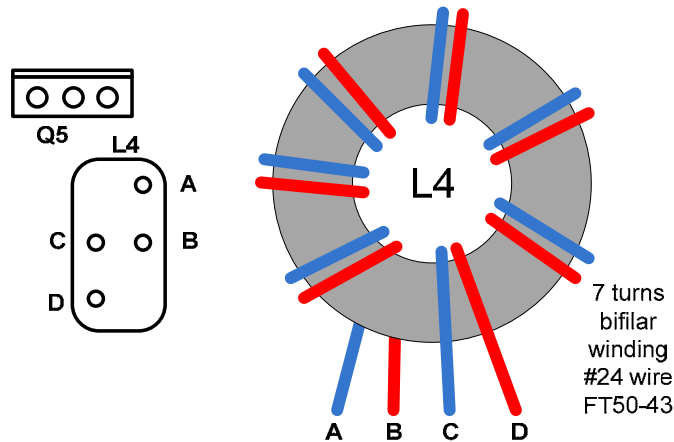

The PCB pad layout makes it quite easy to attach T4 to the PCB since it provides a hole for each lead. Referencing the drawing above the left most blue and right most red leads go into the end holes while the center red and blue leads go in the two central holes of the pad layout.

### Attach Q5 MOSFET to Heatsink

Examine the heatsink bracket and remove any rough spots or metal burs on the side the MOSFET will attach to. If you need to do anything, use steel wool or very light sandpaper.

Re-install the main PCB in the chassis base. Attach the MOSFET to the heatsink; make sure you put the grey heatsink insulator between them. No heat sink paste is required with this type of insulator. The black plastic shoulder washer goes on the heatsink side with the locknut on the Q5 side. Tighten the nut so that it is snug.



Measure continuity between the metal tab of the TO220 MOSFET and the heatsink, you will see about 50 to 80 ohms, a lower value indicates a short and you need to correct this by rechecking the plastic shoulder washer and screw placement.

### **Tx Alignment**

You will need a 50 ohm dummy load and output indicator for this step. Attach the dummy load, a paddle set, and speaker and then turn on power. Keyed 12 volts will be off but there will be 12 volts across the final MOSFET so be careful here, a solder short will give you big trouble.

Set the frequency for mid CW band, 7030 KHz is good. Key the transmitter and you should see some RF output. You may have to advance the Tx bias control clockwise slightly. Re-peak T1 and T2, you should not have to move the slugs very far. You will see some interaction between T1 and T2 to get the best peak. We will redo this later when we adjust for best RF output across the entire CW band. Now peak T3; this will be a very broad peak and is not super critical. Now turn the bias adjust (RX1) clockwise until you see the RF power just start to drop off. Turn the adjustment back to make sure you are just below the peak. You should see about 6-7 watts out for a 12 volt power supply.

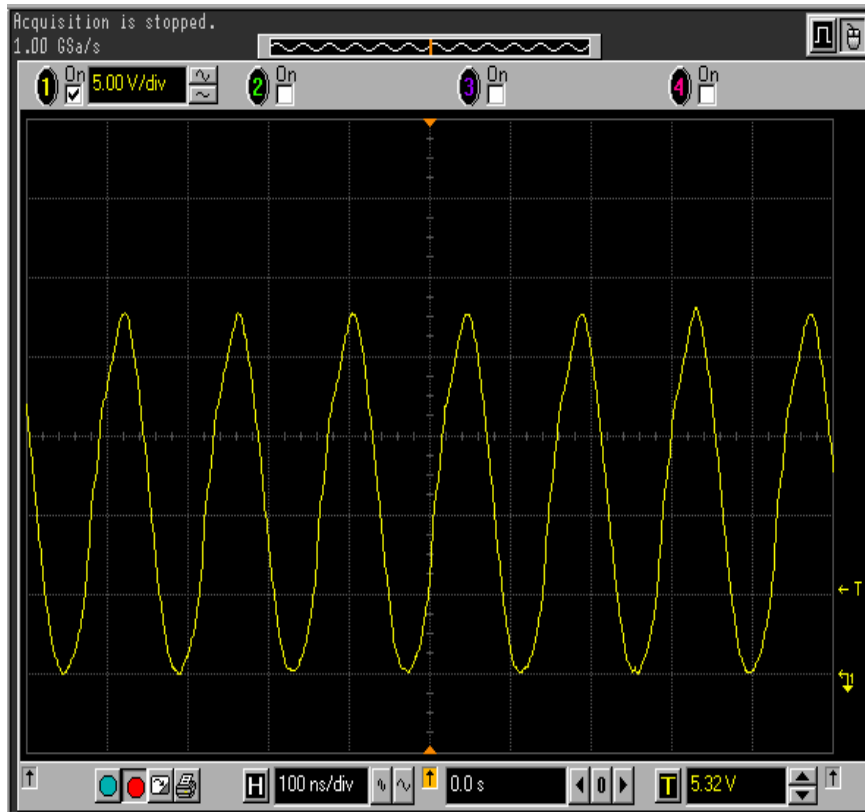

**Q5 Source, DC Coupled, Zero Reference is one division up from bottom. So this waveform is 24 V PtP, bottom at zero**

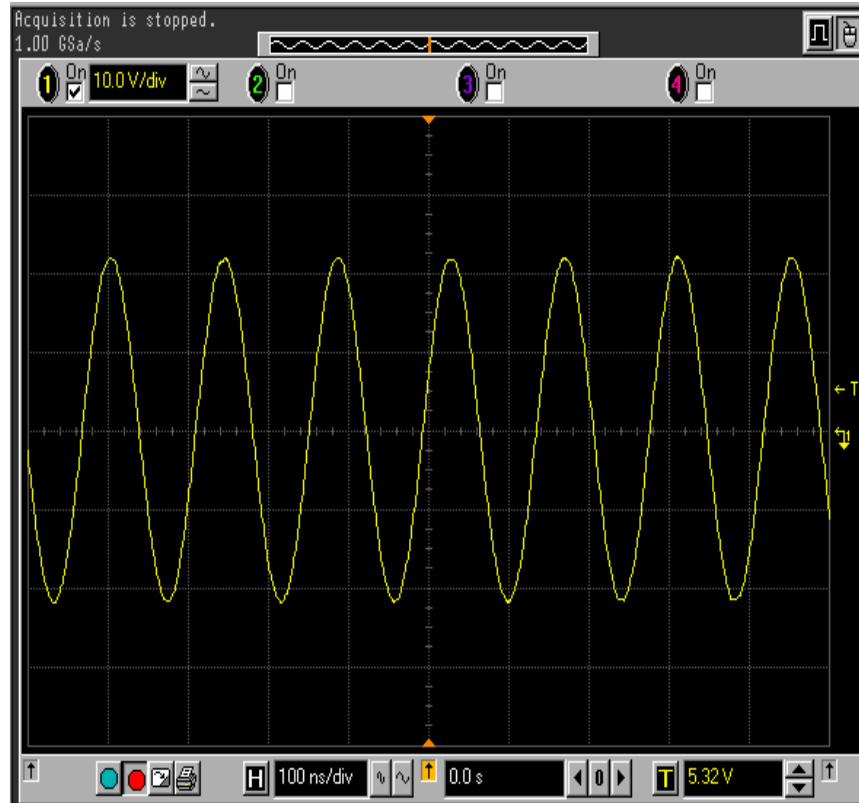

**Tx Output at BNC Connector across 50 ohms, AC Coupled  
Approx 44V PtP is about 4.83 W rms, power supply is at 12 V**

Now it's time to adjust the TX offset, we will use a built in test mode to do this. With power off, press and hold the C/1 pushbutton then turn power on. After a few seconds the LCD will display "Setup". Release the pushbutton. Now press PB6 and the transmitter will be keyed with sidetone inhibited. You will hear the Tx signal as it is sent, carefully tune CT1 so that the beat note exactly matches the sidetone frequency. Press PB4 to hear the reference 690Hz sidetone. By switching PB4 on and off you can easily match the Tx to the sidetone which will exactly set the Tx offset. Press the C/1 pushbutton to leave setup mode.

One last final adjustment, with dummy load still attached set the operating frequency to 7010 KHz. Enable tune mode and adjust T1 for maximum power output. Then turn tune off and change frequency to 7050 KHz. Enable tune and adjust T2 for maximum power output. This broadens the output tuning range to give you an equal power output across the full CW portion of the band.

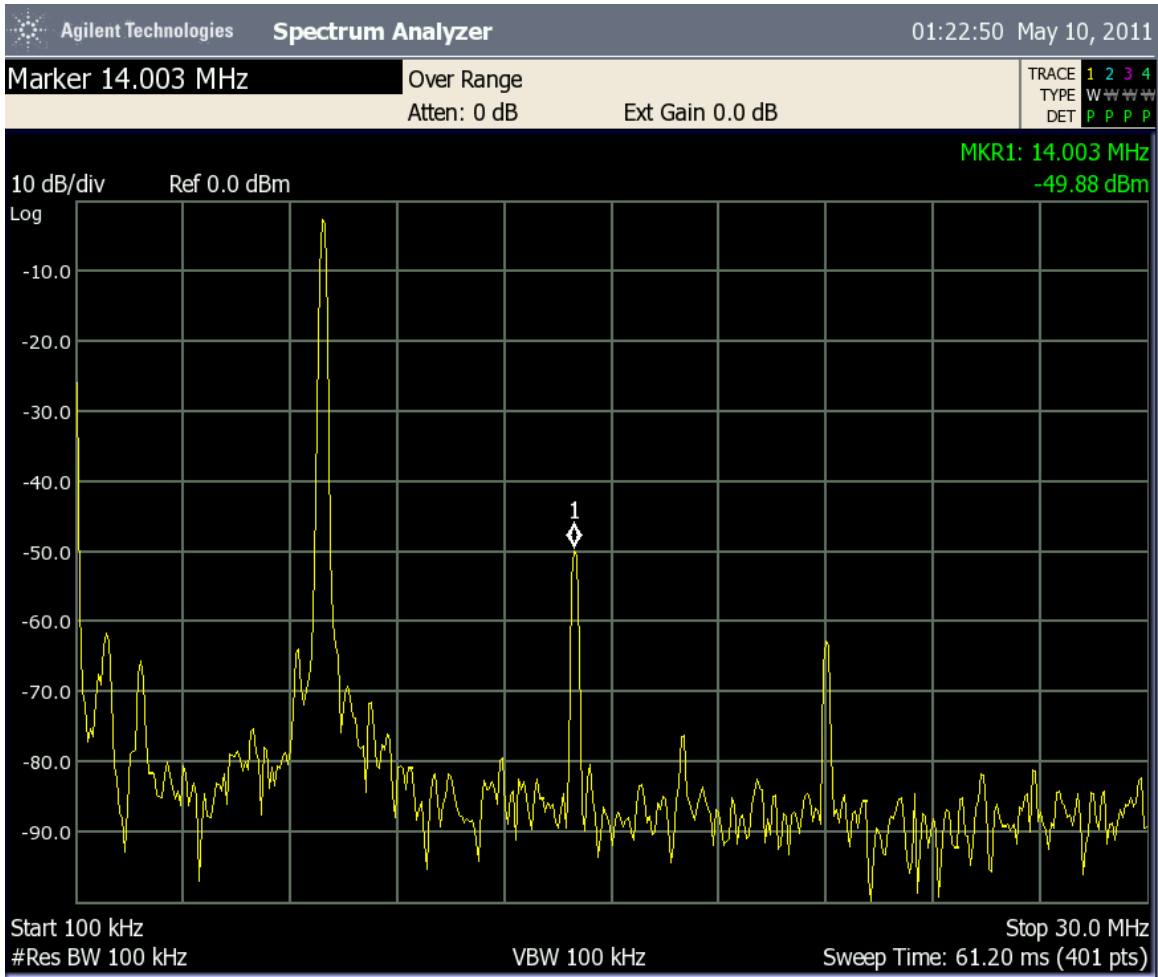

Spectral plot of output amplitude versus frequency. Note that 2<sup>nd</sup> harmonic at 14 MHz is 45dB down from fundamental at 7 MHz.



Completed OQ transceiver